

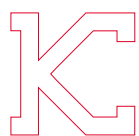

# EXTENDO®

Sistema de puertas correderas telescópicas  
Telescopic sliding doors system  
Système de portes coulissantes télescopiques  
Teleskopisches Schiebetür System



**KLEIN®**

■ EXTENDO®



**ESP**

**Extendo® está diseñado para dividir ambientes mediante un sistema de paneles de vidrio telescópico y sincrónico generando una luz de paso mayor con una zona de aparcamiento reducida.**

- Ideal para dividir espacios instalándolo en cocinas, salones, habitaciones, oficinas, salas de conferencia...
- Sistema innovador para proyectos contemporáneos buscando abrir espacios amplios hasta 5,10 m.
- Sistema de apertura sincronizada de 2, 3 o 4 puertas.
- Zona de paso limpia sin riel en el suelo.
- Perfil de aluminio anodizado "Silver" (AA10 ISO 7599, 10 micras).
- Sujeción de la puerta mediante mordazas a presión sin mecanización del cristal (vidrio templado o laminado).
- Vidrio de 10 mm o 12 mm.
- Rodamientos de bolas para apertura suave.
- Sistema de transmisión premontado y pretensado para un montaje rápido.
- Instalación a pared, a techo, o falso techo.

**Sistemas testados hasta 100.000 ciclos según la norma EN1527.**

**ENG**

**Extendo® has been designed to separate rooms using a system of telescopic, synchronous glass panels to provide increased clearance with the minimal door parking space.**

- Ideal for partitioning kitchens, lounges, bedrooms, offices, conference rooms, etc.
- An innovative system for contemporary projects to open spaces up to 5,10 metres.
- Synchronized opening system of 2, 3 or 4 doors.
- Cleared passageway with no floor profile.
- "Silver" anodized aluminium profile (AA10 ISO 7599, 10 microns).
- Door secured by pressure clamps; no need for mechanized glass (tempered or laminated glass).
- Holds 10 or 12 mm glass.
- Ball bearing system for smooth opening.
- Mounted and tensed transmission system for a quick assembly.
- Wall, ceiling and dropped ceiling mounted.

**Systems tested up to 100.000 cycles as per standard EN1527.**

**FRA**

**Extendo® a été conçu pour la création d'espaces avec un système de panneaux en verre télescopique et synchrone. Il permet d'obtenir une ouverture de passage plus grande et une zone de rangement réduite.**

- Idéal pour la division de cuisines, salons, chambres, bureaux, salles de conférences...
- Système innovant pour projets contemporains avec ouverture de vastes espaces, jusqu'à 5,10 m.
- Système d'ouverture synchronisée de 2, 3 ou 4 portes.
- Zone de passage dégagée, sans guidage au sol.
- Rail en aluminium anodisé "Silver" (AA10 ISO 7599, 10 microns)
- Fixation de la porte par des mâchoires de serrage à pression sans usinage préalable du verre (verre trempé ou laminé).
- Verre de 10 mm ou 12 mm.
- Le roulement à billes assure une ouverture douce.
- Système de transmission prémonté et prétendu pour un montage rapide.
- Installation au mur, au plafond, ou faux plafond.

**Systèmes testés jusqu'à 100.000 cycles selon la norme EN 1527.**

**DEU**

**Extendo® ist dafür ausgelegt, Ambiente durch ein System teleskopischer Glaspaneele mit Gleichlaufmechanik abzutheilen, wobei ein größeres Öffnungsmaß bei verringertem Platzbedarf für die abgestellten Paneele erzielt wird.**

- Ideal zur Teilung von Küche, Wohnzimmer, „Schlafzimmer“, Büros, Konferenzräumen...
- Innovatives System für zeitgemäße Projekte bei denen Räume bis zu 5,10 m weit geöffnet werden sollen.
- Gleichzeitige Öffnung von 2, 3 oder 4 Türen.
- Freier Durchgangsbereich ohne Bodenschiene.
- Silberfarbig eloxierte Aluminiumlaufschiene (AA10 ISO 7599, 10 Mikrons).
- Aufhängung der Tür durch Klemmbeschläge ohne Notwendigkeit der Glasbearbeitung (Einscheiben- oder Verbund-Sicherheitsglas).
- Glas 10 mm oder 12 mm.
- Kugellager für sanftes Öffnen.
- Vormontiertes und vorgespanntes Riemensystem zur schnellen Montage.
- Wand-, Decke-, oder anziehdeckenmontage.

**Systeme gemäß der Norm EN1527 bis 100.000 Zyklen getestet.**

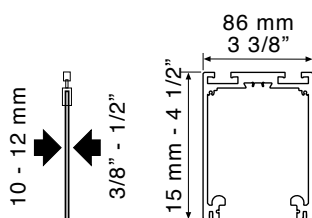
**EXTENDO®**

**LUZ DE PASO / CLEAR OPENING / ZONE DE PASSAGE / ÖFFNUNGSMAB**

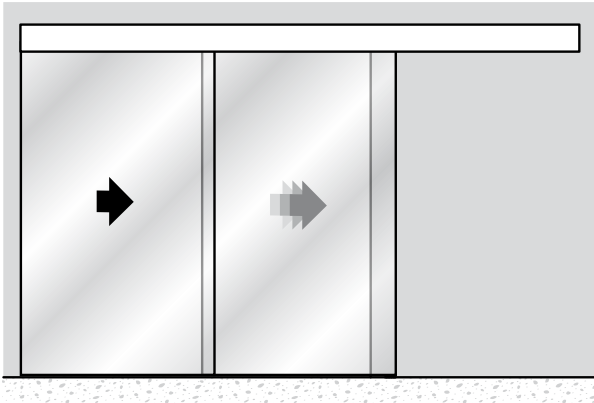

MIN.	MAX.
1.250 mm 4'1 3/16"	2.550 mm 8'4 3/8"

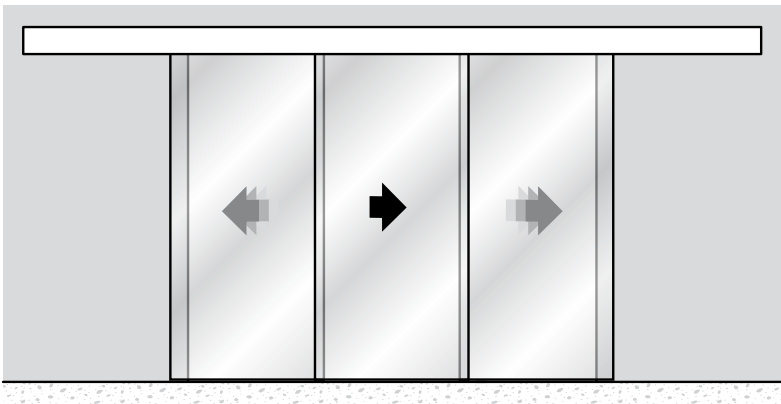

MIN.	MAX.
1.725 mm 5'7 15/16"	2.775 mm 9'1 1/4"

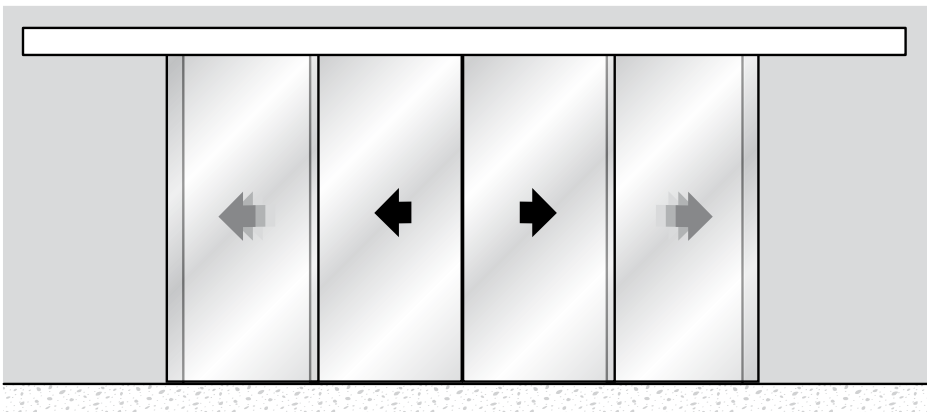

MIN.	MAX.
2.400 mm 7'10 1/2"	3.100 mm 10'2 1/16"

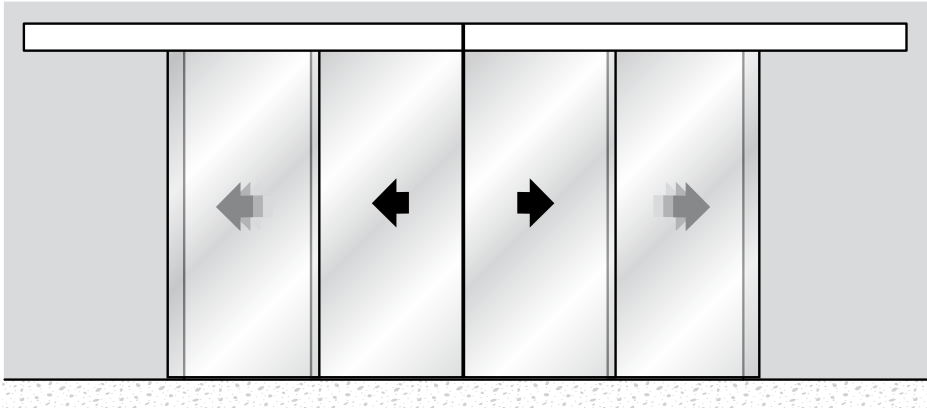

MIN.	MAX.
2.500 mm 8'2 7/16"	5.100 mm 16'8 13/16"

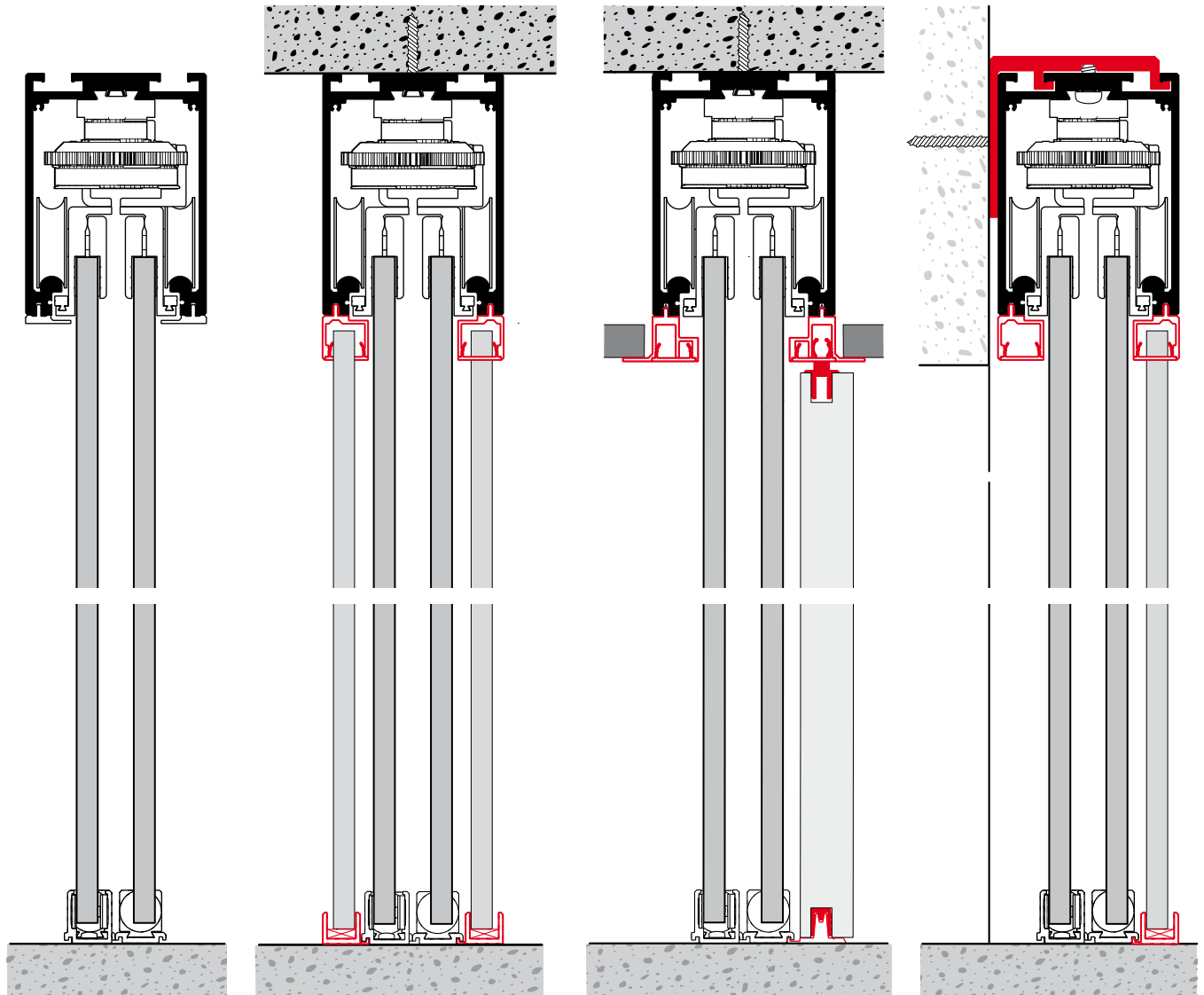
 EXTENDO®

- **ESP** Accesorios disponibles para diversas combinaciones de aplicaciones. Posibilidad de combinar paneles fijos de vidrio y de madera.
- **ENG** Accessories available for diverse combinations of applications. Option of combining fixed glass panels and wood panels.
- **FRA** Accessoires disponibles pour obtenir différentes applications. Il est possible de combiner des panneaux fixes en verres et en bois.
- **DEU** Zubehör für verschiedene Kombinationen und Anwendungen erhältlich. Es besteht die Möglichkeit fixes Paneel aus Glas und Holz zu kombinieren.

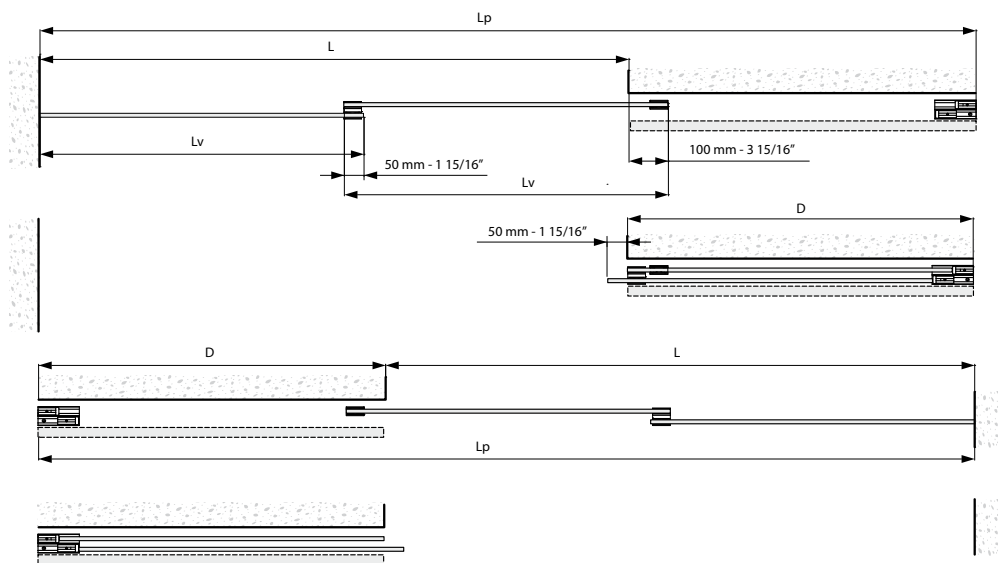
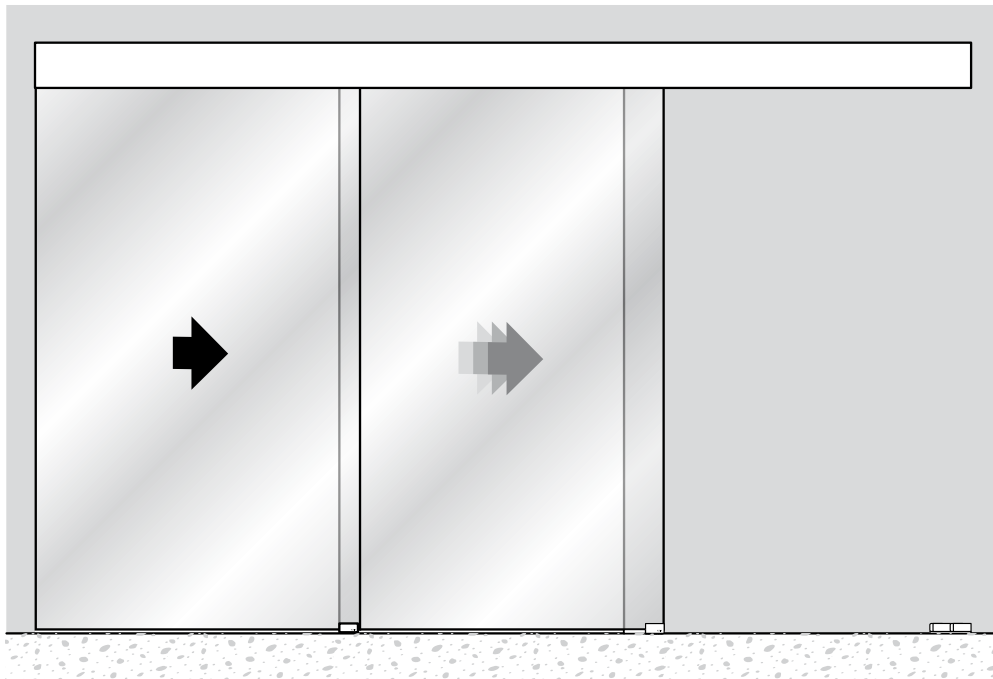

**EXTENDO® 2**

Ref.	L	Lp	hv
1610/1616/1621/1626	1.250-1.550 mm (4' 1 <sup>3</sup> / <sub>16</sub> " - 5' 1")	2.500 mm (8' 2 <sup>7</sup> / <sub>16</sub> " )	≤ 3.000 mm (9' 10 <sup>1</sup> / <sub>8</sub> " )
1612/1617/1622/1627	1.550-1.900 mm (5' 1" - 6' 2 <sup>13</sup> / <sub>16</sub> " )	3.000 mm (9' 10 <sup>1</sup> / <sub>8</sub> " )	≤ 3.000 mm (9' 10 <sup>1</sup> / <sub>8</sub> " )
1613/1618/1623/1628	1.900-2.200 mm (6' 2 <sup>13</sup> / <sub>16</sub> " - 7' 2 <sup>5</sup> / <sub>8</sub> " )	3.500 mm (11' 5 <sup>13</sup> / <sub>16</sub> " )	≤ 3.000 mm (9' 10 <sup>1</sup> / <sub>8</sub> " )
1614 / 1624	2.200-2.550 mm (7' 2 <sup>5</sup> / <sub>8</sub> " - 8' 4 <sup>3</sup> / <sub>8</sub> " )	4.000 mm (13' 1' 1/2")	≤ 2.500 mm (8' 2 <sup>7</sup> / <sub>16</sub> " )
L = _____	$D \geq \frac{L}{2} + 125 \text{ mm (1 } \frac{9}{16} \text{")}$	$Lp = L + D$	$Lv = \frac{L}{2} + 75 \text{ mm (2 } \frac{15}{16} \text{")}$

INTERIORISMO VIDRIO / INTERIOR DESIGN GLASS / DÉCORATION D'INTÉRIEUR VERRE / INNENAUSSTATTUNG GLASS

EXTENDO®

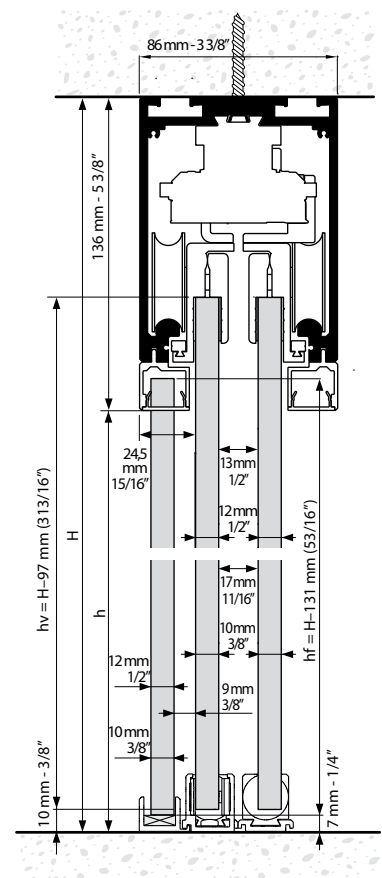
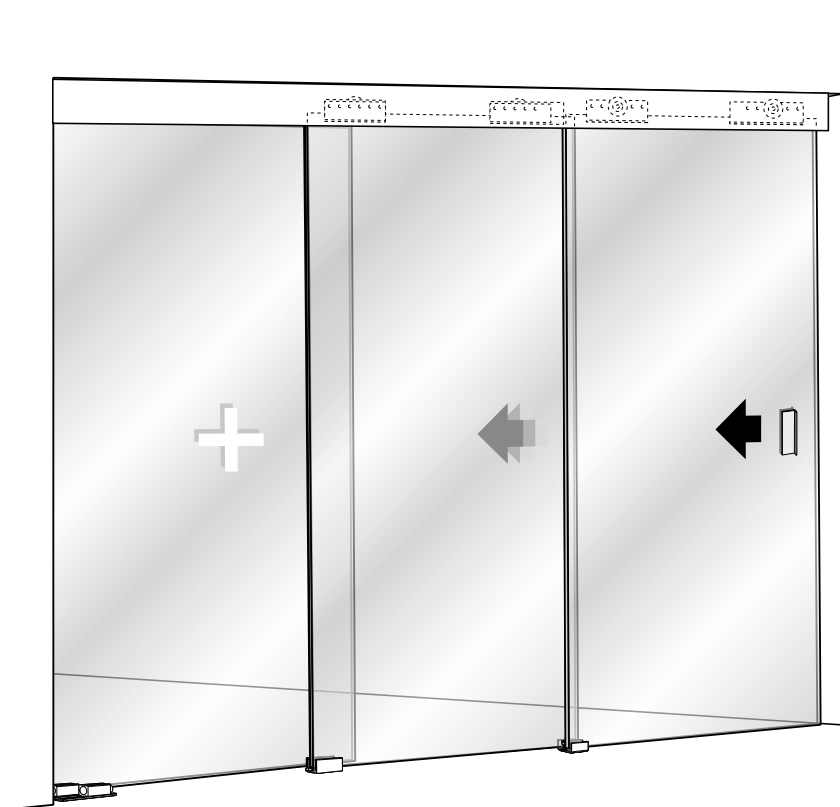
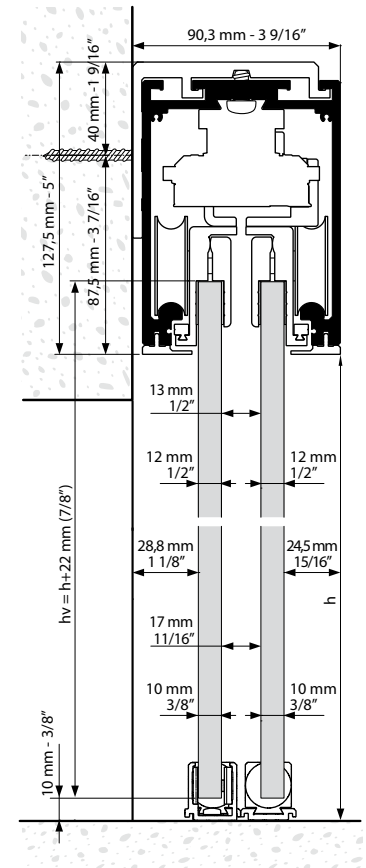
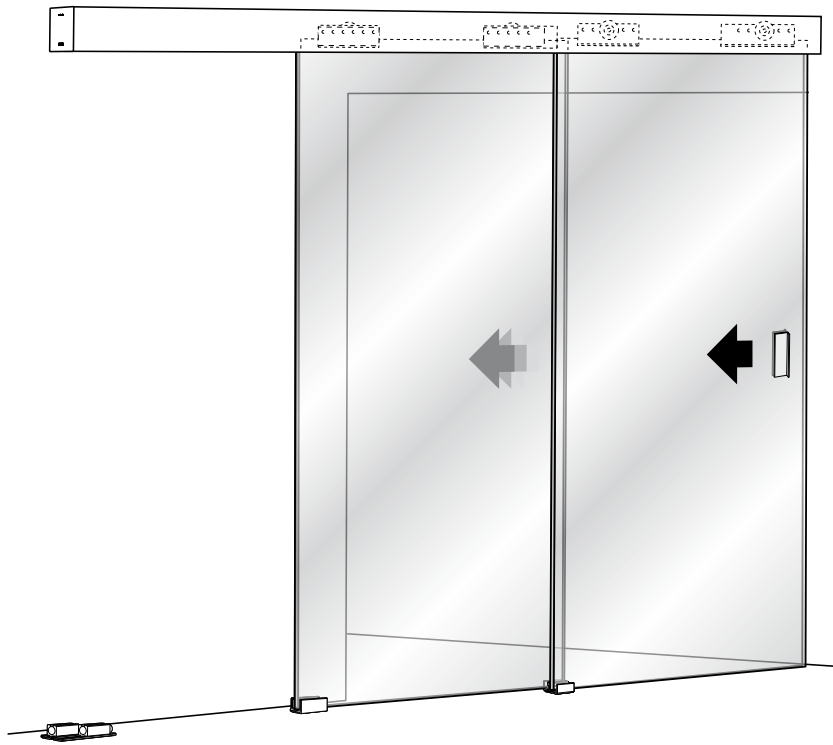
EXTENDO® 2





EXTENDO® 2

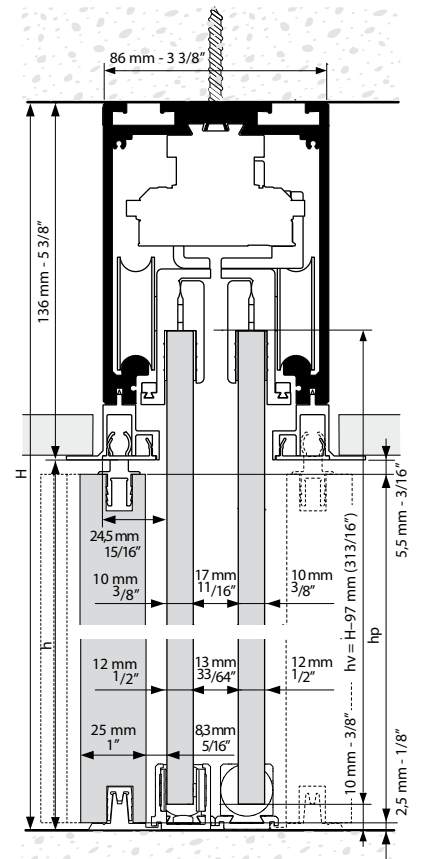
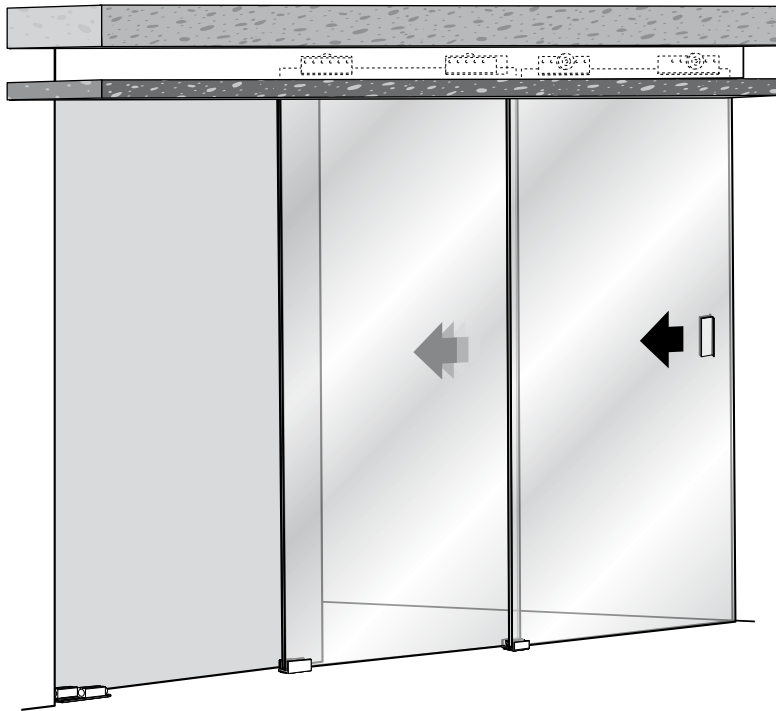
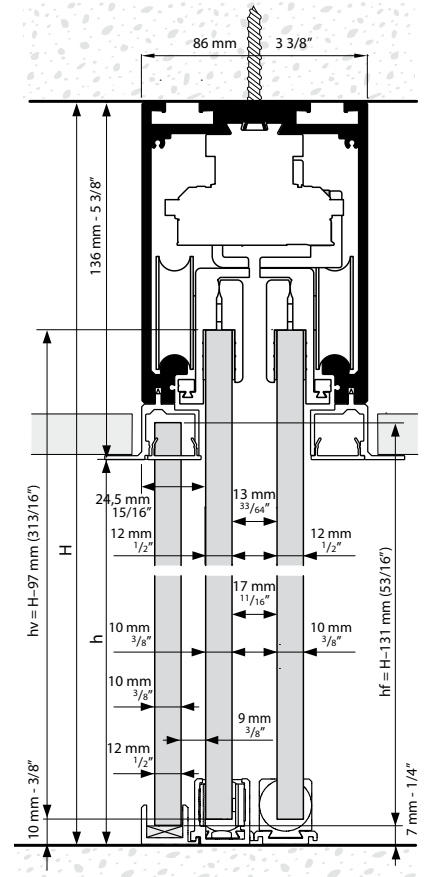
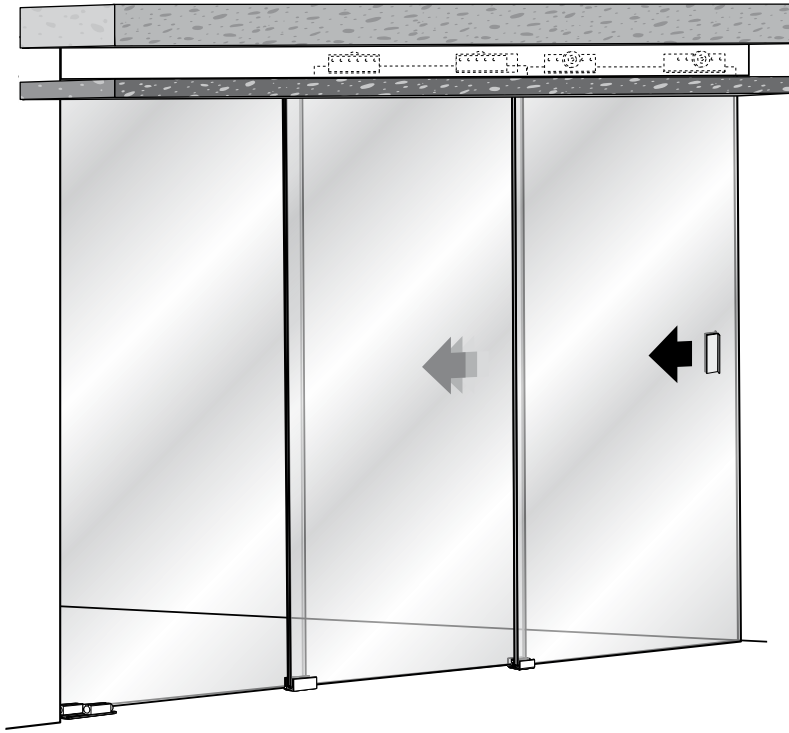



EXTENDO®

**EXTENDO® 3**

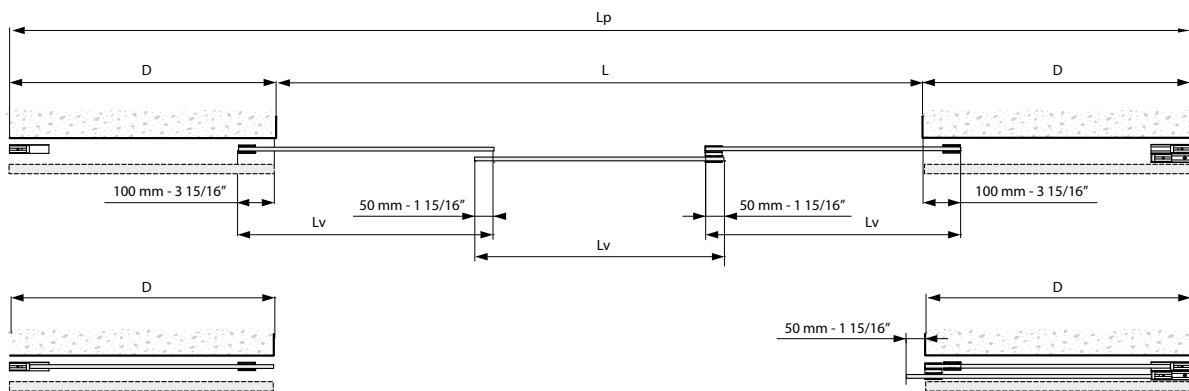
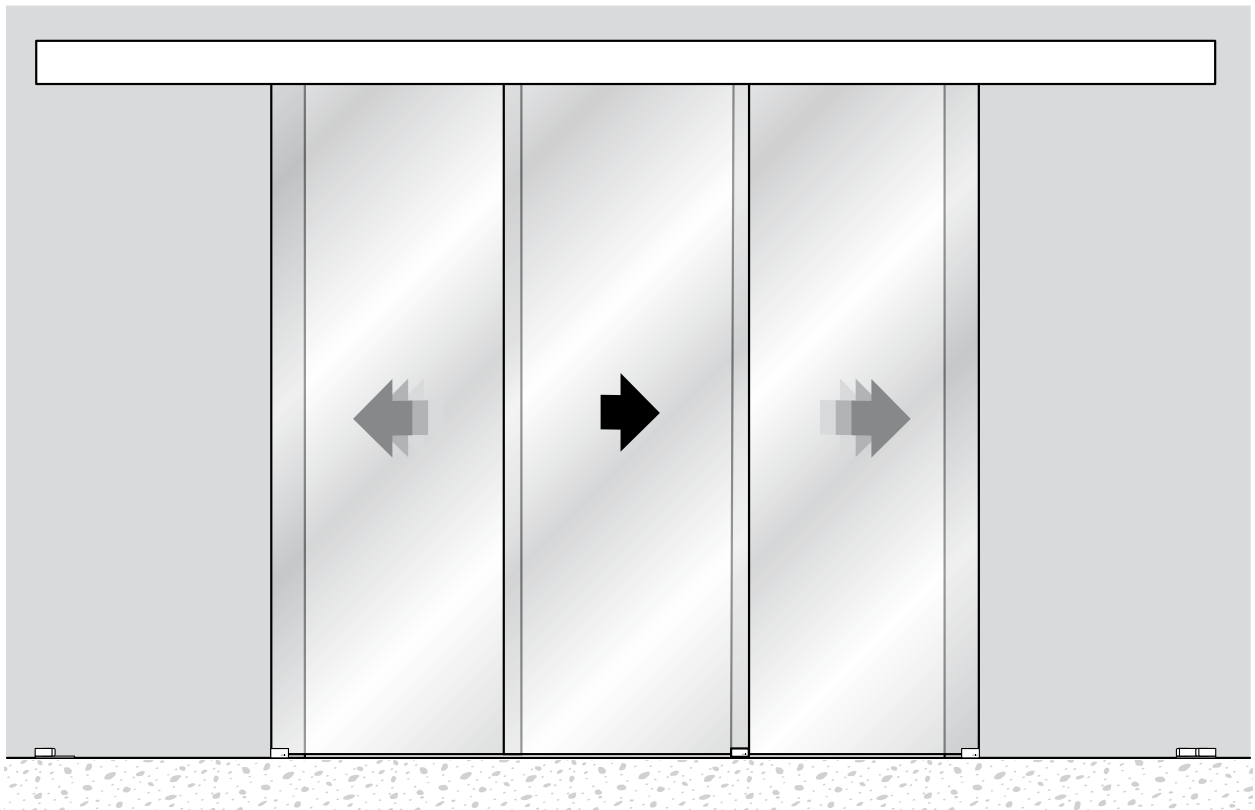

Ref.	L	Lp	hv
1631/1636	1.725-2.175 mm (5' 7 <sup>15</sup> / <sub>16</sub> " - 7' 1 <sup>5</sup> / <sub>8</sub> ")	4.000 mm (13' 1 <sup>1</sup> / <sub>2</sub> ")	≤ 3.000 mm (9' 10 <sup>1</sup> / <sub>8</sub> ")
1632/1637	2.175-2.775 mm (7' 1 <sup>5</sup> / <sub>8</sub> " - 9' 1 <sup>1</sup> / <sub>4</sub> ")	5.000 mm (16' 4 <sup>7</sup> / <sub>8</sub> ")	≤ 2.500 mm (8' 2 <sup>7</sup> / <sub>16</sub> ")

L = _____	$D \geq \frac{L}{3} + 150 \text{ mm (5' 7/8")}$	$Lp = Dx2 + L$	$Lv = \frac{L}{3} + 100 \text{ mm (3' 15/16")}$
-----------	---	----------------	---

EXTENDO® 3

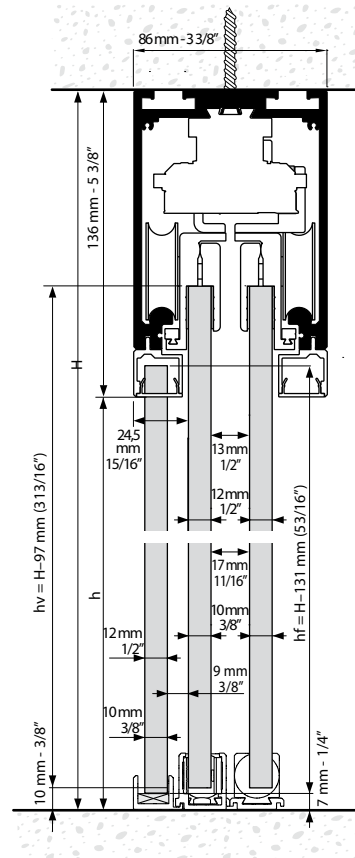
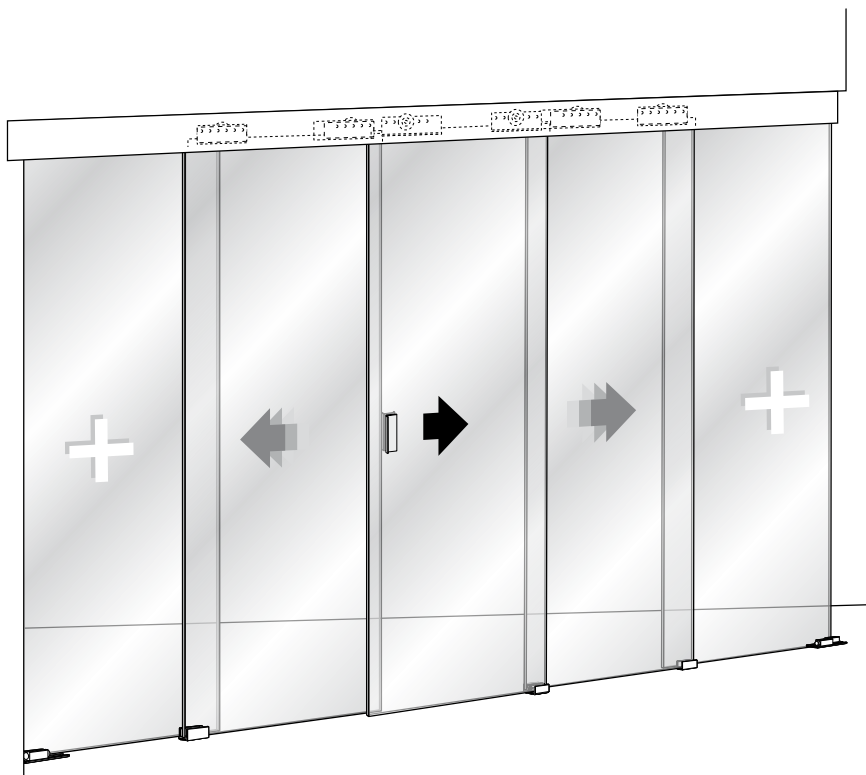
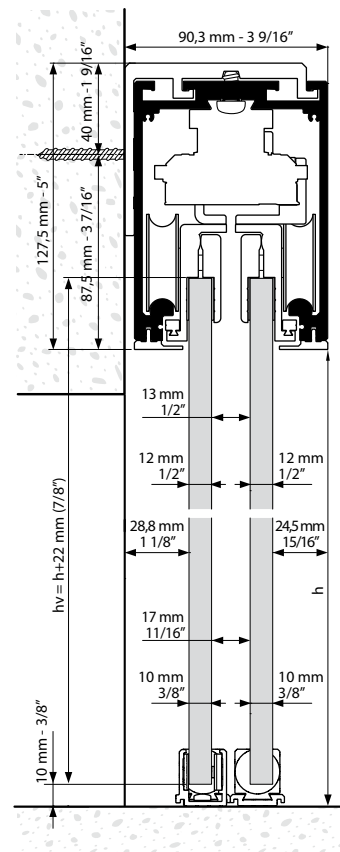
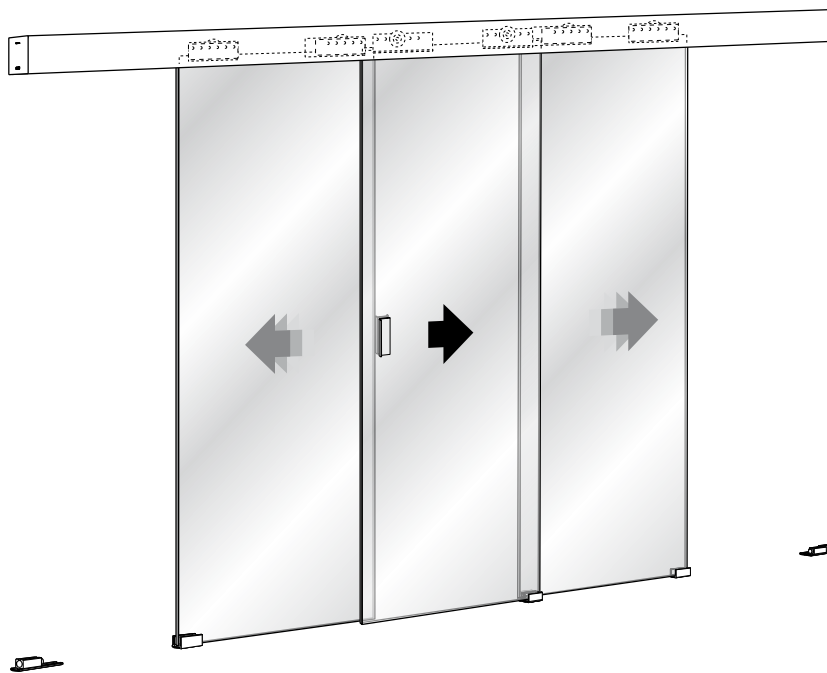

INTERIORISMO VIDRIO / INTERIOR DESIGN GLASS / DÉCORATION D'INTÉRIEUR VERRE / INNENAUSSTATTUNG GLASS

EXTENDO®

EXTENDO® 4

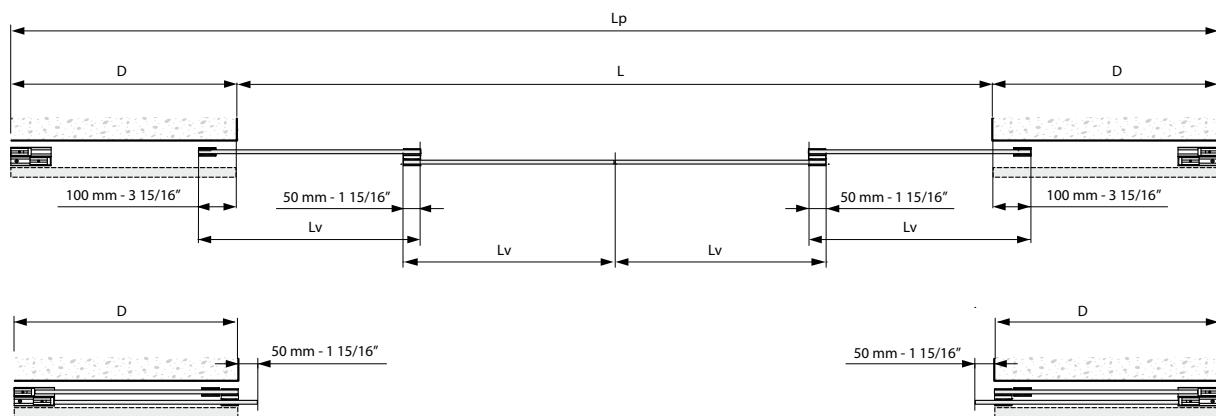
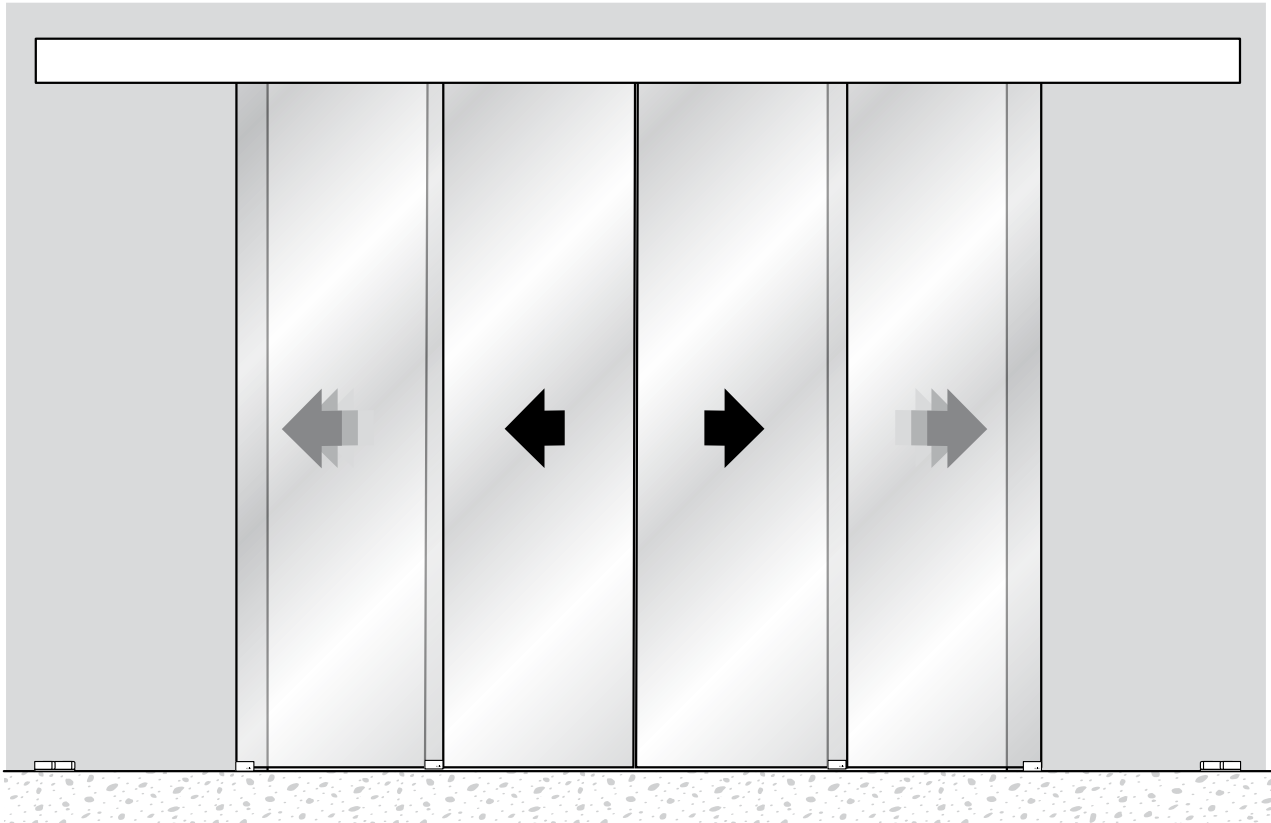

Ref.	L	Lp	hv
1641/1646	2.400-3.100 mm (7' 10 1/2" - 10' 2 1/16")	5.000 mm (16' 4 7/8")	≤ 2.500 mm (8' 2 7/16")
L = _____	$D \geq \frac{L}{4} + 125 \text{ mm (1 9/16")}$	$Lp = Dx2 + L$	$Lv = \frac{L}{4} + 75 \text{ mm (2 15/16")}$

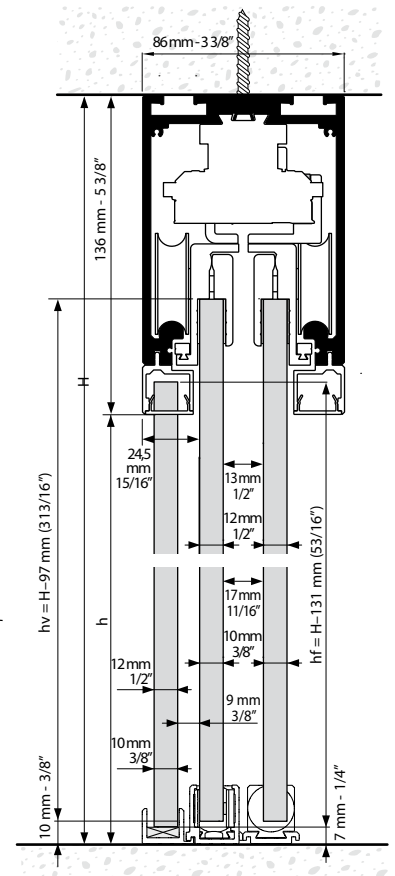
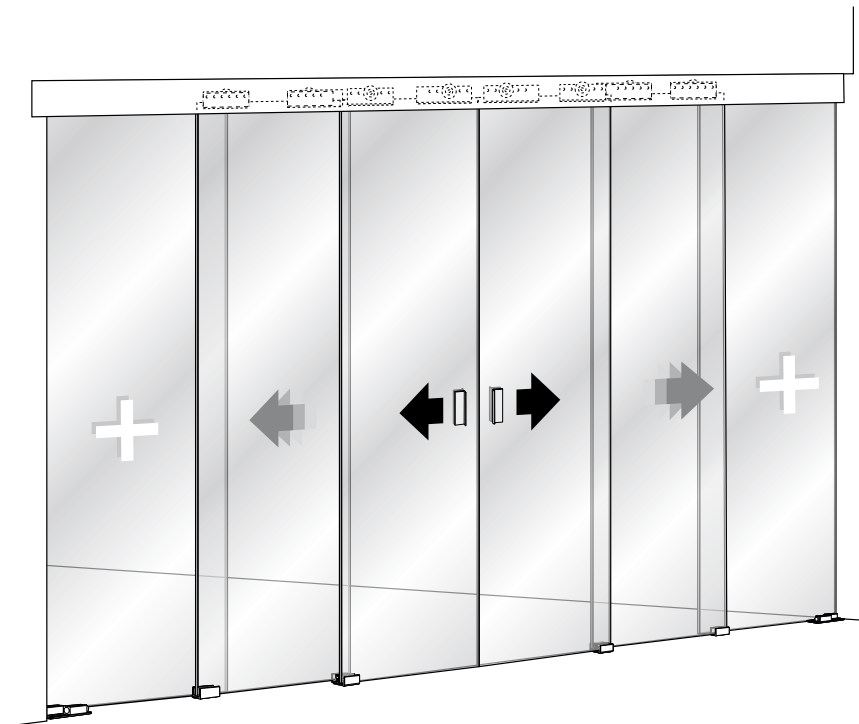
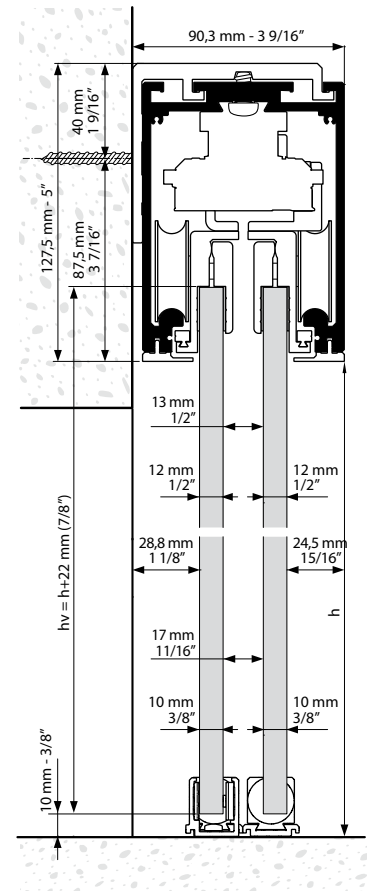
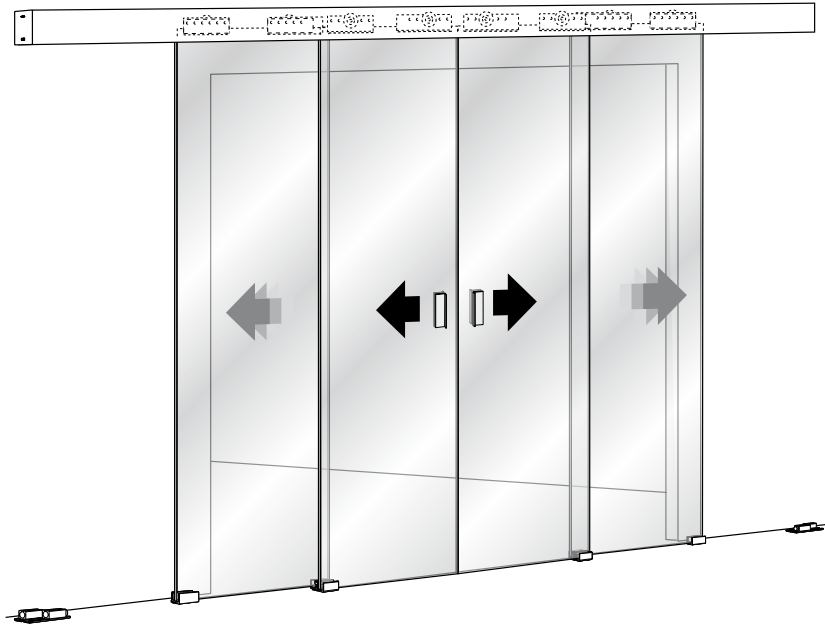
**EXTENDO® 4**

EXTENDO®

**EXTENDO® 4**

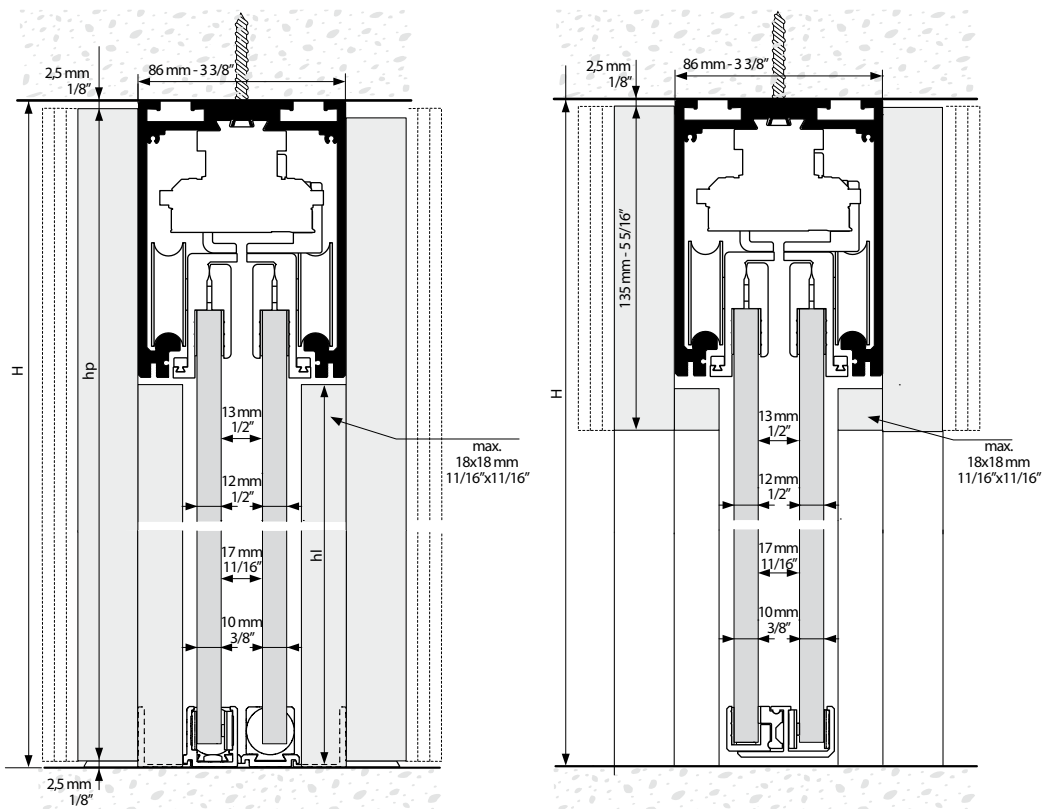
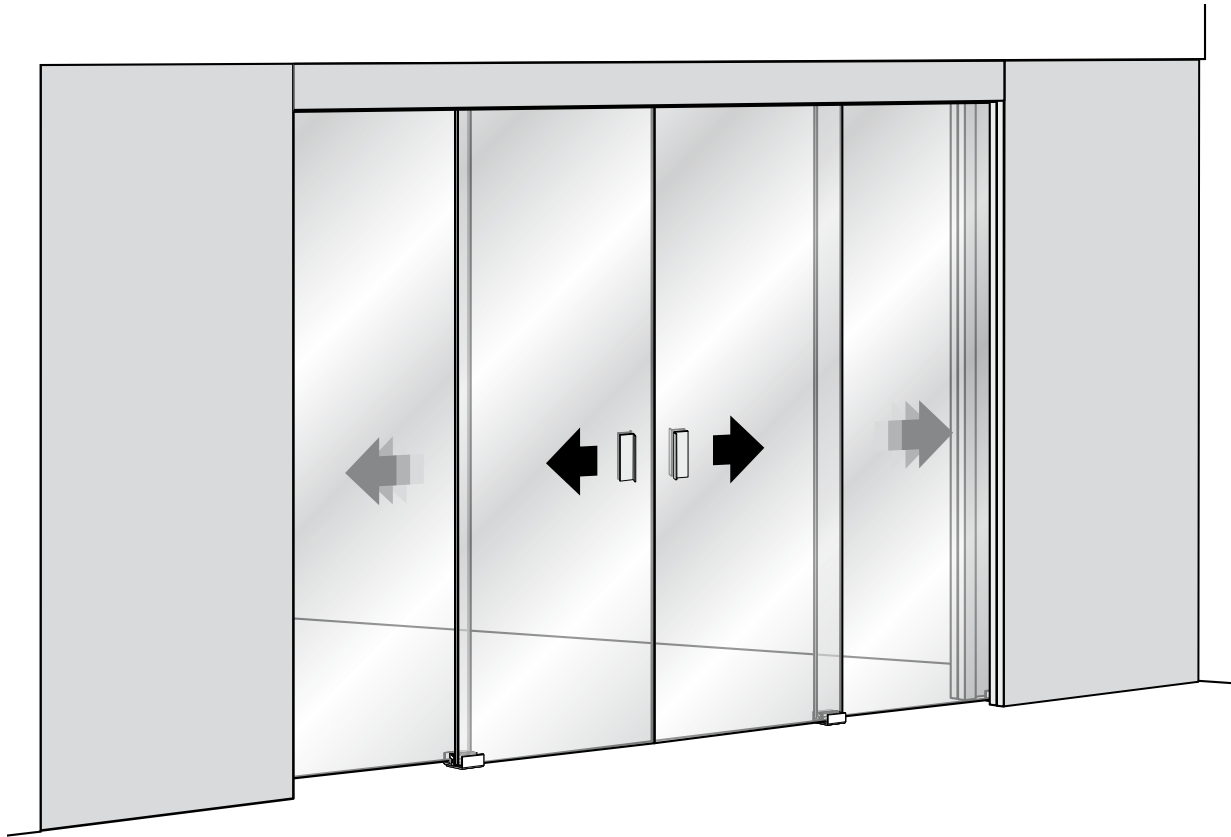

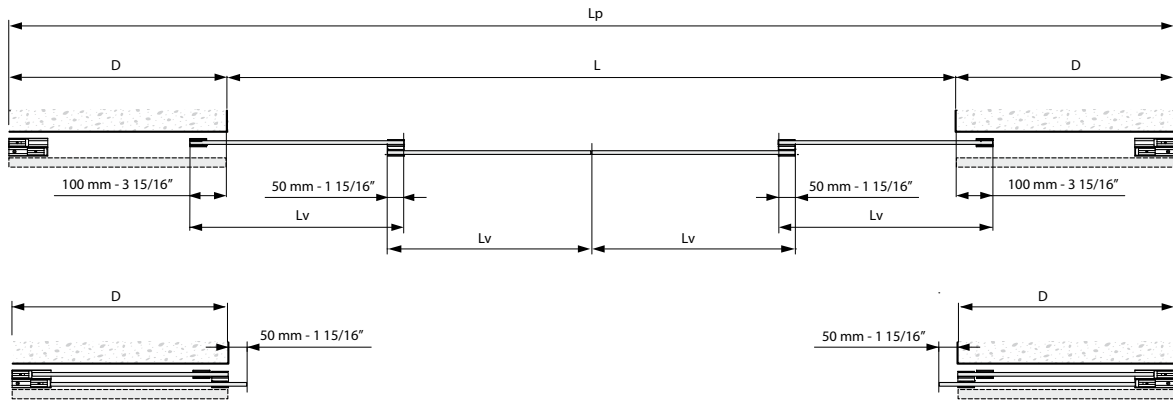
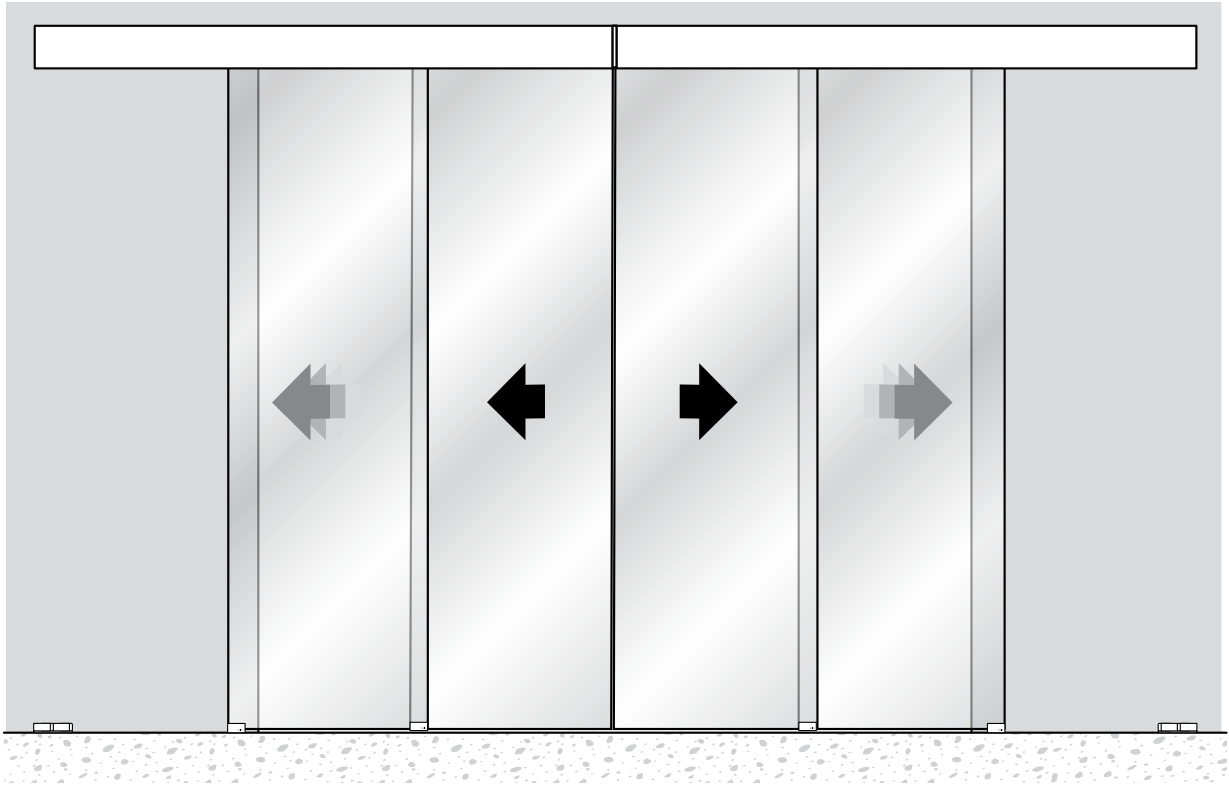

**EXTENDO® 2+2**

Ref.	L	Lp	hv
1610/1616/1621/1626	2.500-3.100 mm (8' 27/16" - 10' 21/16")	2.500 mm (8' 27/16") x2	≤ 3.000 mm (9' 101/16")
1612/1617/1622/1627	3.100-3.800 mm (10' 21/16" - 12' 55/16")	3.000 mm (9' 101/16") x2	≤ 3.000 mm (9' 101/16")
1613/1618/1623/1628	3.800-4.400 mm (12' 55/16" - 14' 51/4")	3.500 mm (11' 513/16") x2	≤ 3.000 mm (9' 101/16")
1614 / 1624	4.400-5.100 mm (14' 51/4" - 16' 813/16")	4.000 mm (13' 11/2") x2	≤ 2.500 mm (8' 27/16")

L = _____	$D \geq \frac{L}{4} + 125 \text{ mm (1 } \frac{9}{16} \text{")}$	$Lp = Dx2 + L$	$Lv = \frac{L}{4} + 75 \text{ mm (2 } \frac{15}{16} \text{")}$
-----------	--	----------------	--

EXTENDO®

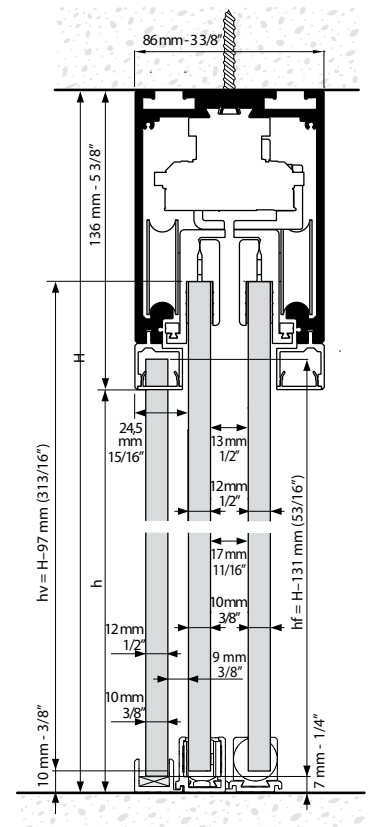
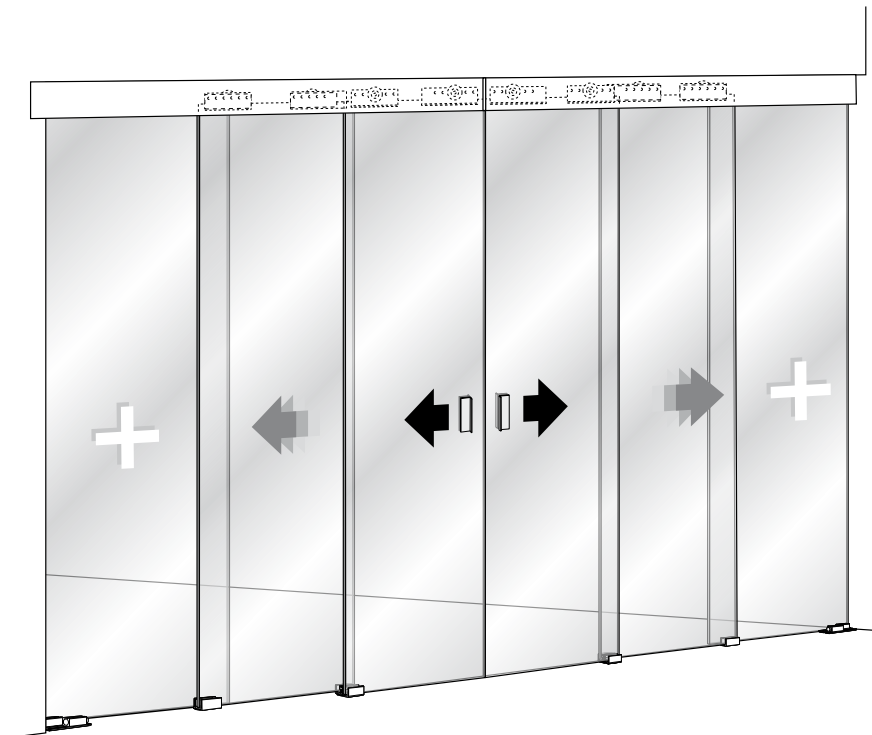
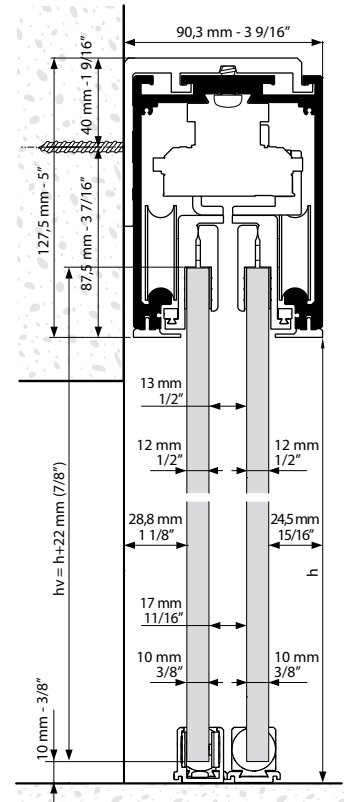
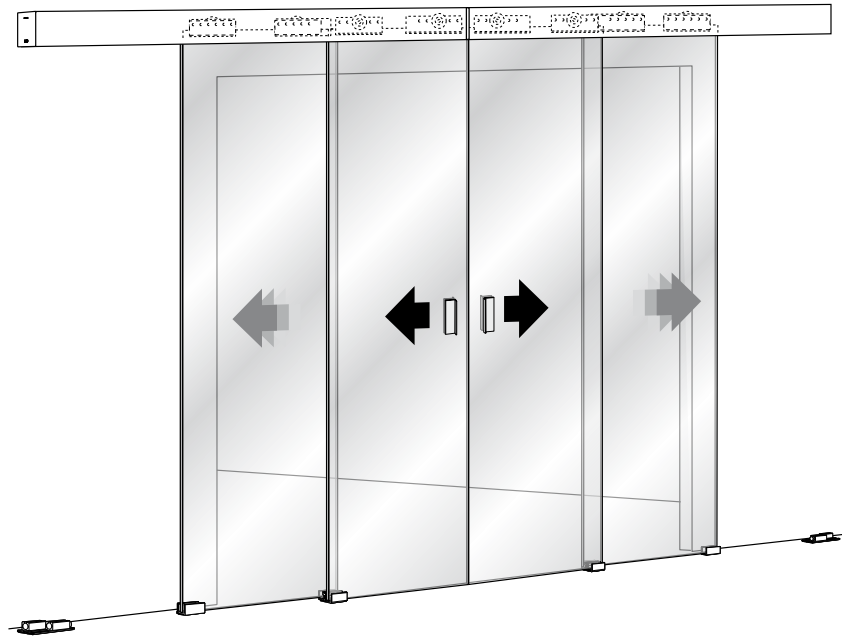
EXTENDO® 2+2







Referencias / References / Références / Referenz

## ESP

EXTENDO®			
Ref.	Descripción	U.	Img.
1610	INST. EXT. 2 HOJAS 2,5 m V10 G-1 APERTURA DERECHA	1	A
1616	INST. EXT. 2 HOJAS 2,5 m V12 G-1 APERTURA DERECHA	1	A
1612	INST. EXT. 2 HOJAS 3 m V10 G-2 APERTURA DERECHA	1	A
1617	INST. EXT. 2 HOJAS 3 m V12 G-2 APERTURA DERECHA	1	A
1613	INST. EXT. 2 HOJAS 3,5 m V10 G-3 APERTURA DERECHA	1	A
1618	INST. EXT. 2 HOJAS 3,5 m V12 G-3 APERTURA DERECHA	1	A
1614	INST. EXT. 2 HOJAS 4 m V10 G-4 APERTURA DERECHA	1	A
1621	INST. EXT. 2 HOJAS 2,5 m V10 G-1 APERTURA IZQUIERDA	1	A
1626	INST. EXT. 2 HOJAS 2,5 m V12 G-1 APERTURA IZQUIERDA	1	A
1622	INST. EXT. 2 HOJAS 3 m V10 G-2 APERTURA IZQUIERDA	1	A
1627	INST. EXT. 2 HOJAS 3 m V12 G-2 APERTURA IZQUIERDA	1	A
1623	INST. EXT. 2 HOJAS 3,5 m V10 G-3 APERTURA IZQUIERDA	1	A
1628	INST. EXT. 2 HOJAS 3,5 m V12 G-3 APERTURA IZQUIERDA	1	A
1624	INST. EXT. 2 HOJAS 4 m V10 G-4 APERTURA IZQUIERDA	1	A
1631	INST. EXT. 3 HOJAS 4 m V10 G-1	1	A
1636	INST. EXT. 3 HOJAS 4 m V12 G-1	1	A
1632	INST. EXT. 3 HOJAS 5 m V10 G-2	1	A
1637	INST. EXT. 3 HOJAS 5 m V12 G-2	1	A
1641	INST. EXT. 4 HOJAS 5 m V10 G-1	1	A
1646	INST. EXT. 4 HOJAS 5 m V12 G-1	1	A
1652	SOPORTE PARED ALU. ANOD. SILVER 3 m	1	B
1654	SOPORTE PARED ALU. ANOD. SILVER 4 m	1	B
1655	SOPORTE PARED ALU. ANOD. SILVER 5 m	1	B
1662	JGO. PF. ALU. ANOD. SILVER VIDRIO FIJO 3 m	1	C
1664	JGO. PF. ALU. ANOD. SILVER VIDRIO FIJO 4 m	1	C
1665	JGO. PF. ALU. ANOD. SILVER VIDRIO FIJO 5 m	1	C
1672	JGO. PF. MADERA ALU. ANOD. SILVER F.TECHO 3 m	1	D
1674	JGO. PF. MADERA ALU. ANOD. SILVER F.TECHO 4 m	1	D
1675	JGO. PF. MADERA ALU. ANOD. SILVER F.TECHO 5 m	1	D
1682	JGO. PF. VIDRIO ALU. ANOD. SILVER F.TECHO 3 m	1	E
1684	JGO. PF. VIDRIO ALU. ANOD. SILVER F.TECHO 4 m	1	E
1685	JGO. PF. VIDRIO ALU. ANOD. SILVER F.TECHO 5 m	1	E
1691	PF. INF. ALU. ANOD. SILVER VIDRIO FIJO 2 m	1	F
1693	JGO.TAPAS ALU. ANOD. SILVER LATERAL CORTO	1	G
1694	JGO.TAPAS ALU. ANOD. SILVER LATERAL LARGO	1	H
1695	PF. NF. ALU. ANOD. SILVER TABLERO MADERA 2 m	1	I

## ENG

EXTENDO®			
Ref.	Description	Units	Img.
1610	INST. EXT. 2 Doors 2,5 m V10 G-1 RIGHT OPENING	1	A
1616	INST. EXT. 2 Doors 2,5 m V12 G-1 RIGHT OPENING	1	A
1612	INST. EXT. 2 Doors 3 m V10 G-2 RIGHT OPENING	1	A
1617	INST. EXT. 2 Doors 3 m V12 G-2 RIGHT OPENING	1	A
1613	INST. EXT. 2 Doors 3,5 m V10 G-3 RIGHT OPENING	1	A
1618	INST. EXT. 2 Doors 3,5 m V12 G-3 RIGHT OPENING	1	A
1614	INST. EXT. 2 Doors 4 m V10 G-4 RIGHT OPENING	1	A
1621	INST. EXT. 2 Doors 2,5 m V10 G-1 LEFT OPENING	1	A
1626	INST. EXT. 2 Doors 2,5 m V12 G-1 LEFT OPENING	1	A
1622	INST. EXT. 2 Doors 3 m V10 G-2 LEFT OPENING	1	A
1627	INST. EXT. 2 Doors 3 m V12 G-2 LEFT OPENING	1	A
1623	INST. EXT. 2 Doors 3,5 m V10 G-3 LEFT OPENING	1	A
1628	INST. EXT. 2 Doors 3,5 m V12 G-3 LEFT OPENING	1	A
1624	INST. EXT. 2 Doors 4 m V10 G-4 LEFT OPENING	1	A
1631	INST. EXT. 3 Doors 4 m V10 G-1	1	A
1636	INST. EXT. 3 Doors 4 m V12 G-1	1	A
1632	INST. EXT. 3 Doors 5 m V10 G-2	1	A
1637	INST. EXT. 3 Doors 5 m V12 G-2	1	A
1641	INST. EXT. 3 Doors 5 m V10 G-1	1	A
1646	INST. EXT. 3 Doors 5 m V12 G-1	1	A
1652	WALL BRACKET ALU. ANOD. SILVER 3 m	1	B
1654	WALL BRACKET ALU. ANOD. SILVER 4 m	1	B
1655	WALL BRACKET ALU. ANOD. SILVER 5 m	1	B
1662	SET OF PF. ALU. ANOD. SILVER FOR FIX GLASS 3 m	1	C
1664	SET OF PF. ALU. ANOD. SILVER FOR FIX GLASS 4 m	1	C
1665	SET OF PF. ALU. ANOD. SILVER FOR FIX GLASS 5 m	1	C
1672	SET OF PF. ALU. ANOD. SILVER FOR FIX WOOD PANEL-DROPPED CEILING 3 m	1	D
1674	SET OF PF. ALU. ANOD. SILVER FOR FIX WOOD PANEL-DROPPED CEILING 4 m	1	D
1675	SET OF PF. ALU. ANOD. SILVER FOR FIX WOOD PANEL-DROPPED CEILING 5 m	1	D
1682	SET OF PF. ALU. ANOD. SILVER FOR FIX GLASS-DROPPED CEILING 3 m	1	E
1684	SET OF PF. ALU. ANOD. SILVER FOR FIX GLASS-DROPPED CEILING 4 m	1	E
1685	SET OF PF. ALU. ANOD. SILVER FOR FIX GLASS-DROPPED CEILING 5 m	1	E
1691	BOTTOM PF. ALU. ANOD. SILVER TO HOLD FIX GLASS 2 m	1	F
1693	SET OF LATERAL COVERS ALU. ANOD. SILVER SHORT OPTION	1	G
1694	SET OF LATERAL COVERS ALU. ANOD. SILVER LONG OPTION	1	H
1695	BOTTOM PF. ALU. ANOD. SILVER TO HOLD FIX WOOD PANEL 2 m	1	I

## INTERIORISMO VIDRIO / INTERIOR DESIGN GLASS / DÉCORATION D'INTÉRIEUR VERRE / INNENAUSSTATTUNG GLASS



Referencias / References / Références / Referenz

## FRA

EXTENDO®			
Ref.	Description	Unités	Img.
1610	INST. EXT. 2 PANNEAUX 2,5 m V10 G-1 OUVERTURE DROITE	1	A
1616	INST. EXT. 2 PANNEAUX 2,5 m V12 G-1 OUVERTURE DROITE	1	A
1612	INST. EXT. 2 PANNEAUX 3 m V10 G-2 OUVERTURE DROITE	1	A
1617	INST. EXT. 2 PANNEAUX 3 m V12 G-2 OUVERTURE DROITE	1	A
1613	INST. EXT. 2 PANNEAUX 3,5 m V10 G-3 OUVERTURE DROITE	1	A
1618	INST. EXT. 2 PANNEAUX 3,5 m V12 G-3 OUVERTURE DROITE	1	A
1614	INST. EXT. 2 PANNEAUX 4 m V10 G-4 OUVERTURE DROITE	1	A
1621	INST. EXT. 2 PANNEAUX 2,5 m V10 G-1 OUVERTURE GAUCHE	1	A
1626	INST. EXT. 2 PANNEAUX 2,5 m V12 G-1 OUVERTURE GAUCHE	1	A
1622	INST. EXT. 2 PANNEAUX 3 m V10 G-2 OUVERTURE GAUCHE	1	A
1627	INST. EXT. 2 PANNEAUX 3 m V12 G-2 OUVERTURE GAUCHE	1	A
1623	INST. EXT. 2 PANNEAUX 3,5 m V10 G-3 OUVERTURE GAUCHE	1	A
1628	INST. EXT. 2 PANNEAUX 3,5 m V12 G-3 OUVERTURE GAUCHE	1	A
1624	INST. EXT. 2 PANNEAUX 4 m V10 G-4 OUVERTURE GAUCHE	1	A
1631	INST. EXT. 3 PANNEAUX 4 m V10 G-1	1	A
1636	INST. EXT. 3 PANNEAUX 4 m V12 G-1	1	A
1632	INST. EXT. 3 PANNEAUX 5 m V10 G-2	1	A
1637	INST. EXT. 3 PANNEAUX 5 m V12 G-2	1	A
1641	INST. EXT. 4 PANNEAUX 5 m V10 G-1	1	A
1646	INST. EXT. 4 PANNEAUX 5 m V12 G-1	1	A
1652	SUPPORT MURAL ALU. ANOD. SILVER 3 m	1	B
1654	SUPPORT MURAL ALU. ANOD. SILVER 4 m	1	B
1655	SUPPORT MURAL ALU. ANOD. SILVER 5 m	1	B
1662	JEU RAIL ALU. ANOD. SILVER VERRE FIXE 3 m	1	C
1664	JEU RAIL ALU. ANOD. SILVER VERRE FIXE 4 m	1	C
1665	JEU RAIL ALU. ANOD. SILVER VERRE FIXE 5 m	1	C
1672	JEU RAIL ALU. ANOD. SILVER BOIS FIXE FAUX-PLAFOND 3 m	1	D
1674	JEU RAIL ALU. ANOD. SILVER BOIS FIXE FAUX-PLAFOND 4 m	1	D
1675	JEU RAIL ALU. ANOD. SILVER BOIS FIXE FAUX-PLAFOND 5 m	1	D
1682	JEU RAIL ALU. ANOD. SILVER VERRE FIXE FAUX-PLAFOND 3 m	1	E
1684	JEU RAIL ALU. ANOD. SILVER VERRE FIXE FAUX-PLAFOND 4 m	1	E
1685	JEU RAIL ALU. ANOD. SILVER VERRE FIXE FAUX-PLAFOND 5 m	1	E
1691	RAIL INF. ALU. ANOD. SILVER PANNEAU VERRE FIXE 2 m	1	F
1693	JEU CACHES ALU. ANOD. SILVER LATÉRAUX COURTS	1	G
1694	JEU CACHES ALU. ANOD. SILVER LATÉRAUX LONGS	1	H
1695	RAIL INF. ALU. ANOD. SILVER PANNEAU BOIS FIXE 2 m	1	I

## DEU

EXTENDO®			
Ref.	Beschreibung	Ein.	Bild
1610	INST. EXT. 2 FLÜGEL 2,5 m V10 G-1 RECHTS ÖFFNUNG	1	A
1616	INST. EXT. 2 FLÜGEL 2,5 m V12 G-1 RECHTS ÖFFNUNG	1	A
1612	INST. EXT. 2 FLÜGEL 3 m V10 G-2 RECHTS ÖFFNUNG	1	A
1617	INST. EXT. 2 FLÜGEL 3 m V12 G-2 RECHTS ÖFFNUNG	1	A
1613	INST. EXT. 2 FLÜGEL 3,5 m V10 G-3 RECHTS ÖFFNUNG	1	A
1618	INST. EXT. 2 FLÜGEL 3,5 m V12 G-3 RECHTS ÖFFNUNG	1	A
1614	INST. EXT. 2 FLÜGEL 4 m V10 G-4 RECHTS ÖFFNUNG	1	A
1621	INST. EXT. 2 FLÜGEL 2,5 m V10 G-1 LINKS ÖFFNUNG	1	A
1626	INST. EXT. 2 FLÜGEL 2,5 m V12 G-1 LINKS ÖFFNUNG	1	A
1622	INST. EXT. 2 FLÜGEL 3 m V10 G-2 LINKS ÖFFNUNG	1	A
1627	INST. EXT. 2 FLÜGEL 3 m V12 G-2 LINKS ÖFFNUNG	1	A
1623	INST. EXT. 2 FLÜGEL 3,5 m V10 G-3 LINKS ÖFFNUNG	1	A
1628	INST. EXT. 2 FLÜGEL 3,5 m V12 G-3 LINKS ÖFFNUNG	1	A
1624	INST. EXT. 2 FLÜGEL 4 m V10 G-4 LINKS ÖFFNUNG	1	A
1631	INST. EXT. 3 FLÜGEL 4 m V10 G-1	1	A
1636	INST. EXT. 3 FLÜGEL 4 m V12 G-1	1	A
1632	INST. EXT. 3 FLÜGEL 5 m V10 G-2	1	A
1637	INST. EXT. 3 FLÜGEL 5 m V12 G-2	1	A
1641	INST. EXT. 4 FLÜGEL 5 m V10 G-1	1	A
1646	INST. EXT. 4 FLÜGEL 5 m V12 G-1	1	A
1652	WANDBEFESTIGUNG ALU. ANOD. SILVER 3 m	1	B
1654	WANDBEFESTIGUNG ALU. ANOD. SILVER 4 m	1	B
1655	WANDBEFESTIGUNG ALU. ANOD. SILVER 5 m	1	B
1662	PROFILSET ALU. ANOD. SILVER FÜR FIXES GLASS 3 m	1	C
1664	PROFILSET ALU. ANOD. SILVER FÜR FIXES GLASS 4 m	1	C
1665	PROFILSET ALU. ANOD. SILVER FÜR FIXES GLASS 5 m	1	C
1672	PROFILSET ALU. ANOD. SILVER FÜR FIXES HOLZPANEL AN EINZIEHDECKE 3 m	1	D
1674	PROFILSET ALU. ANOD. SILVER FÜR FIXES HOLZPANEL AN EINZIEHDECKE 4 m	1	D
1675	PROFILSET ALU. ANOD. SILVER FÜR FIXES HOLZPANEL AN EINZIEHDECKE 5 m	1	D
1682	PROFILSET ALU. ANOD. SILVER FÜR FIXES GLASS AN EINZIEHDECKE 3 m	1	E
1684	PROFILSET ALU. ANOD. SILVER FÜR FIXES GLASS AN EINZIEHDECKE 4 m	1	E
1685	PROFILSET ALU. ANOD. SILVER FÜR FIXES GLASS AN EINZIEHDECKE 5 m	1	E
1691	UNTERES PROFIL ALU. ANOD. SILVER FÜR FIXES GLASS 2 m	1	F
1693	SET FÜR KURZE SEITENABDECKUNG ALU. ANOD. SILVER	1	G
1694	SET FÜR LANGE SEITENABDECKUNG FÜR FIXES GLASS ALU. ANOD. SILVER	1	H
1695	UNTERES PROFIL ALU. ANOD. SILVER FÜR FIXES HOLZPANEL 2 m	1	I

EXTENDO®



A

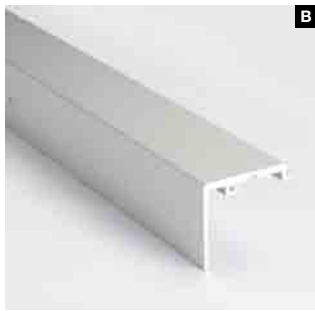

B



C



E

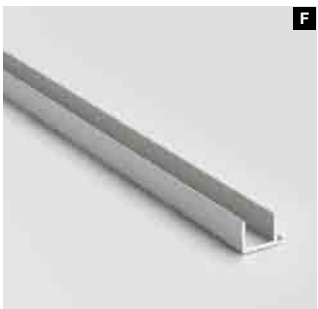

F



D



G



H

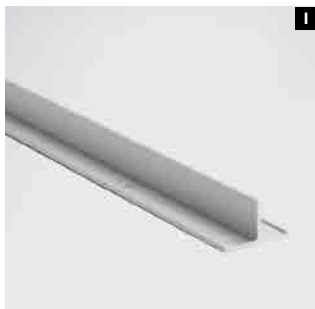

I

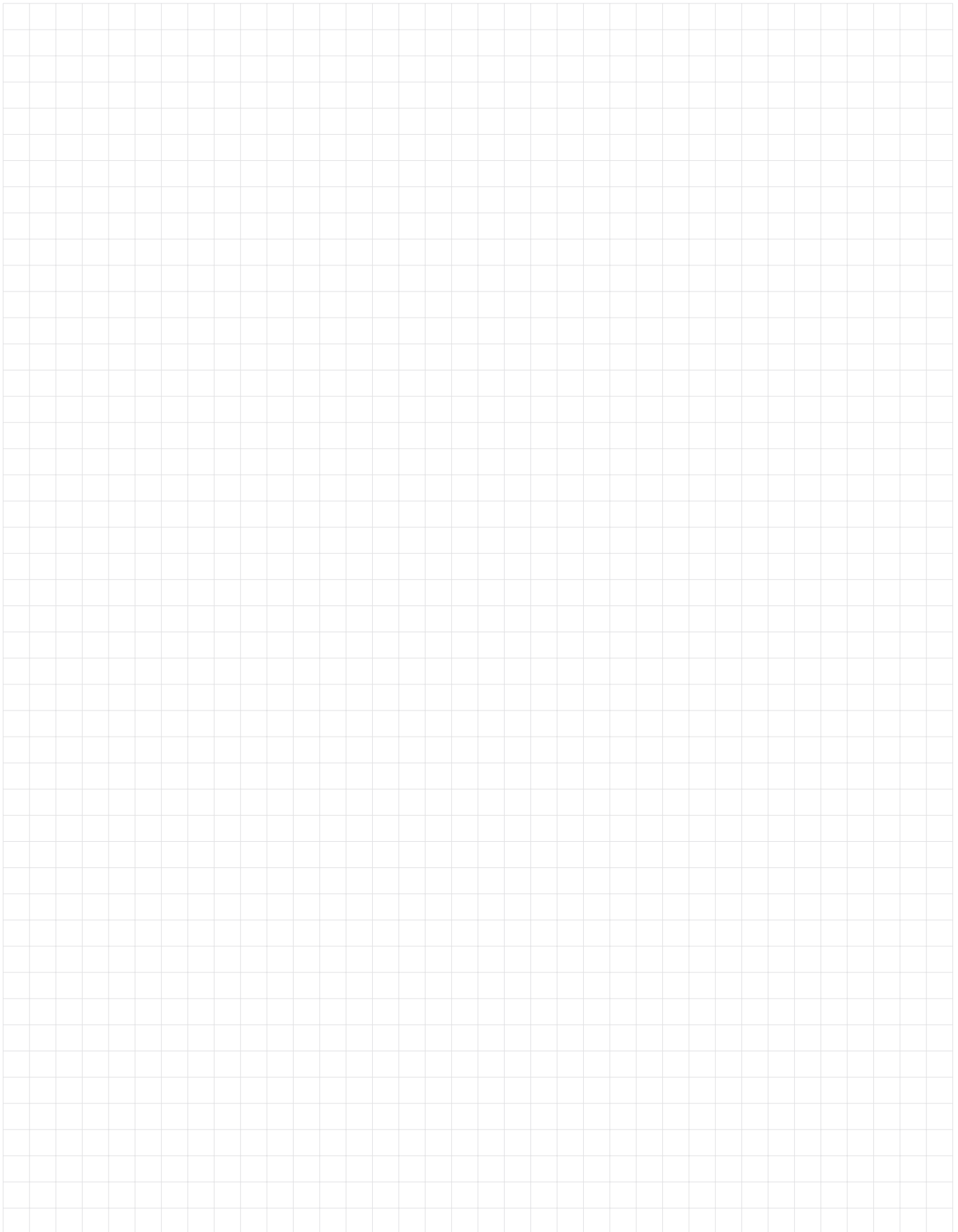

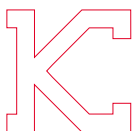

**KLEIN EUROPE**

Edificio KLEIN  
Polígono Industrial Can Cuyás  
N-150 Km.1  
08110 Montcada i Reixac  
(Barcelona-Spain)

Tel: (+34) 935 760 101

Fax: (+34) 935 760 109

+INFO

[klein@klein-europe.com](mailto:klein@klein-europe.com)

[www.klein-europe.com](http://www.klein-europe.com)

**KLEIN®**