

# Klasik Klasik Clear

An enclosure of medium height suitable for everyone, a traditional product you will never stop enjoying... that is our Klasik enclosure. Choose an enclosure that will serve you for many years.





# Klasik / Klasik Clear

Series

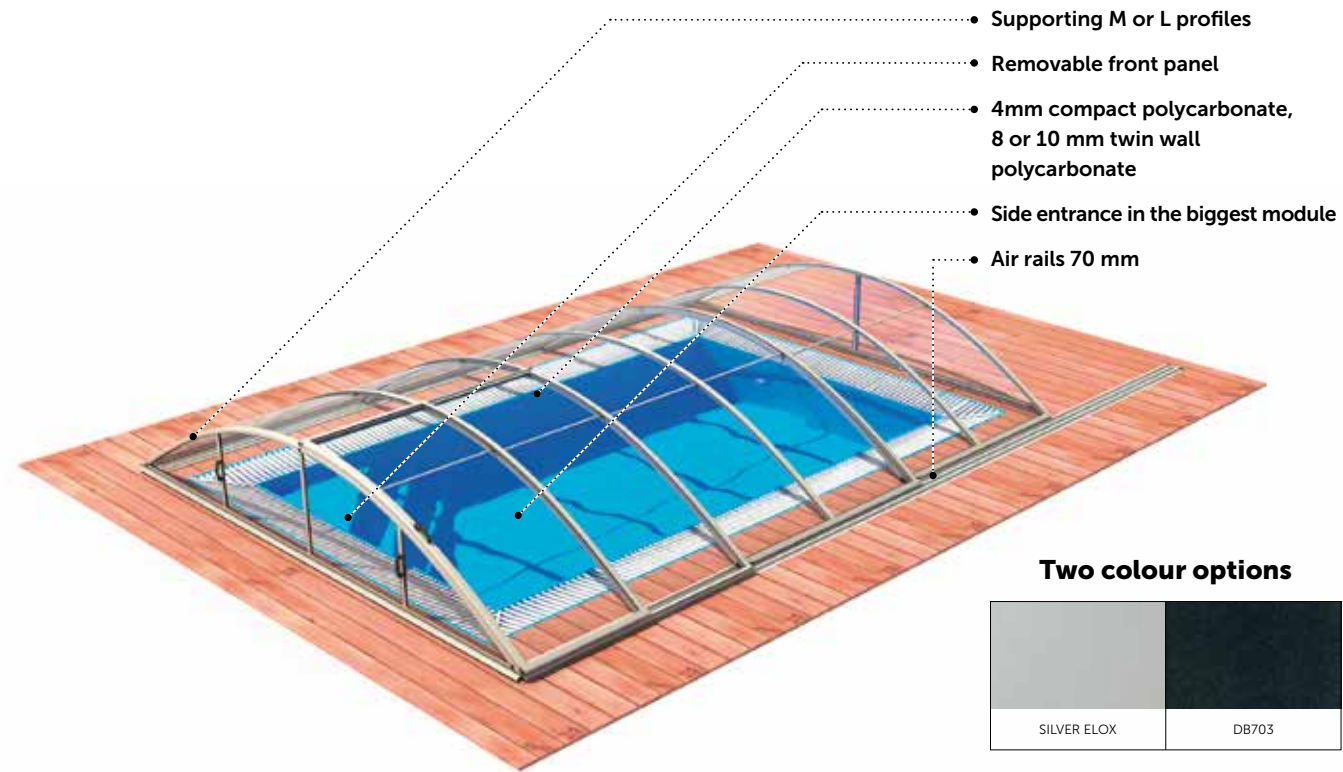

**i** The enclosure is delivered with rails on the left and right side in the length of the enclosure. For moving the enclosure outside of the area of the pool, we recommend buying extension rails. More information on enclosure equipment, colour options and technical details can be found on pages 98 - 105.

Technical details	Klasik A / *Klasik Clear A	Klasik B / *Klasik Clear B	Klasik C / *Klasik Clear C
Maximum enclosed area	319 x 635 cm	415 x 850 cm	501 x 1060 cm
Outer width „B”	361 cm	471 cm	571 cm
Inner width „A”	333 cm	429 cm	515 cm
Outer length „E”	646 cm	860 cm	1073 cm
Outer height „V”	100 cm	130 cm	155 cm
Package size	430 x 41 x 157 cm	563 x 45 x 188 cm	606 x 61 x 175 cm
Package weight	250 kg / *350 kg	420 kg / *570 kg	610 kg / *840 kg
Installation time	ca 1 h/3 pers. / *ca 2 h/3 pers.	ca 2 h/3 os. / *ca 4 h/3 pers.	ca 3 h/3 os. / *ca 6 h/3 pers.

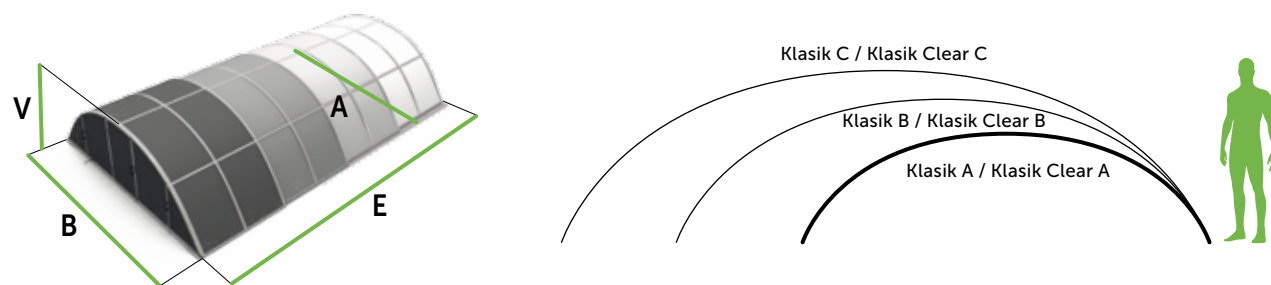

## BOX main advantages

- ✓ limited editions
- ✓ ready for shipping
- ✓ quick and simple installation

# Klasik / Klasik Clear

Custom

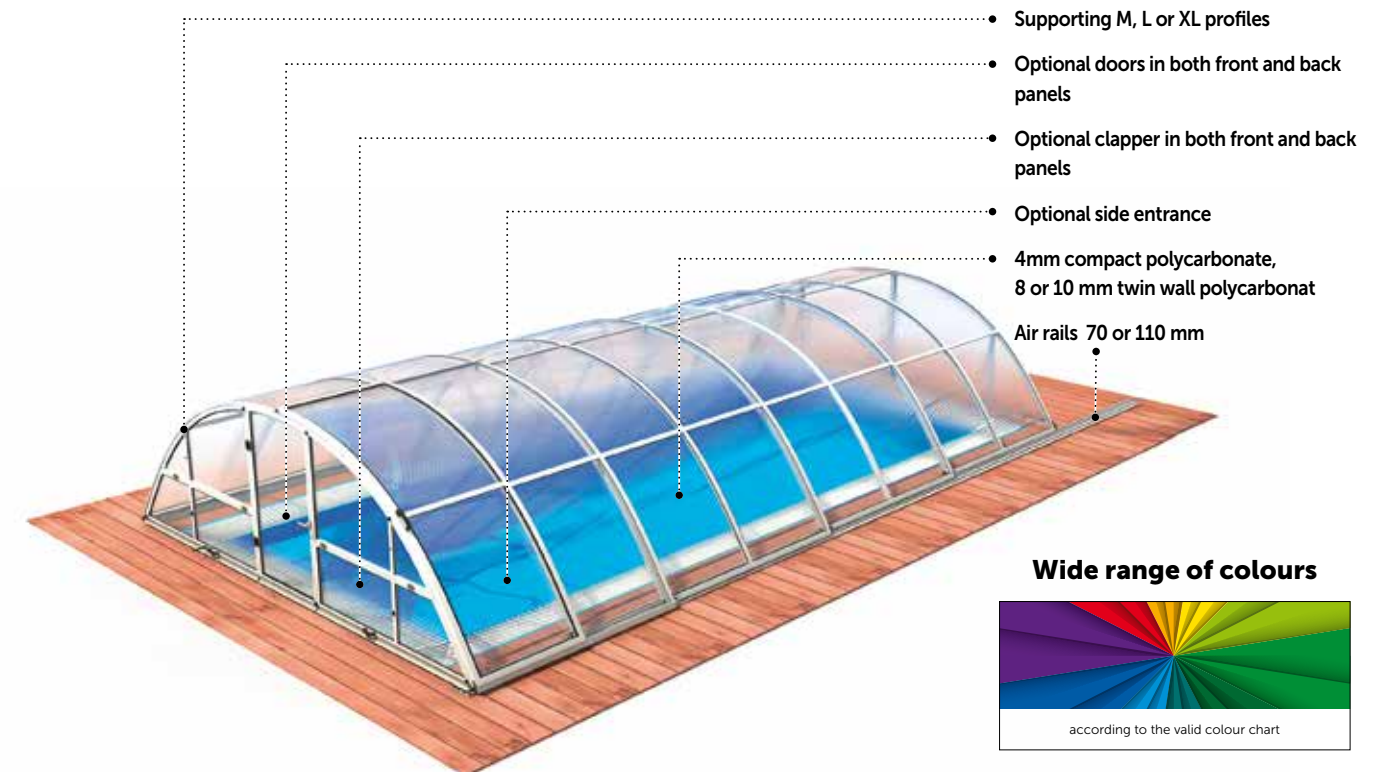

**i** The enclosure is delivered with rails on the left and right side in the length of the enclosure. For moving the enclosure outside of the area of the pool, we recommend buying extension rails. More information on enclosure equipment, colour options and technical details can be found on pages 98 - 105.

Possible enclosure sizes	Klasik / Klasik Clear
Width „B”	od 201 do 900 cm
Height „V”	od 70 do 350 cm
Length „E”	unlimited

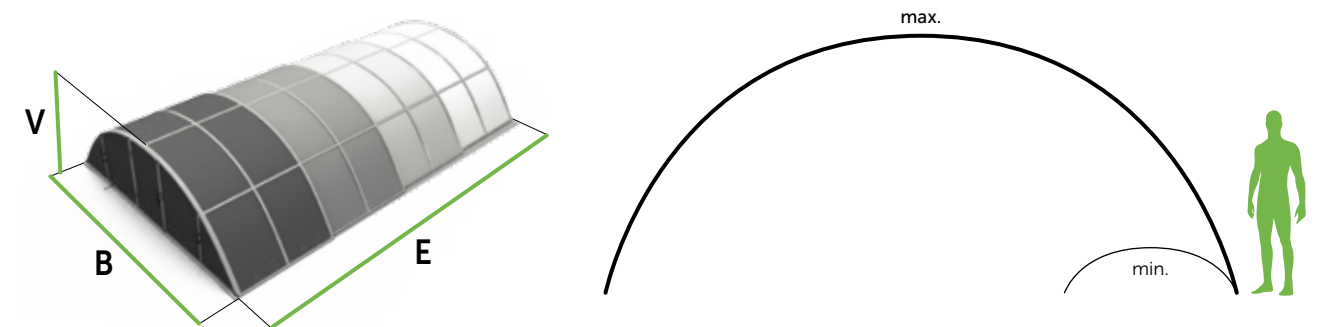

## Custom production options

- ✓ Individual enclosure sizes
- ✓ Choice of roofing material type and colour
- ✓ Individual configuration
- ✓ Wide range of over 40 colours and decors of the supporting structure
- ✓ Door type and location as per your request

# KLASIK A 2016

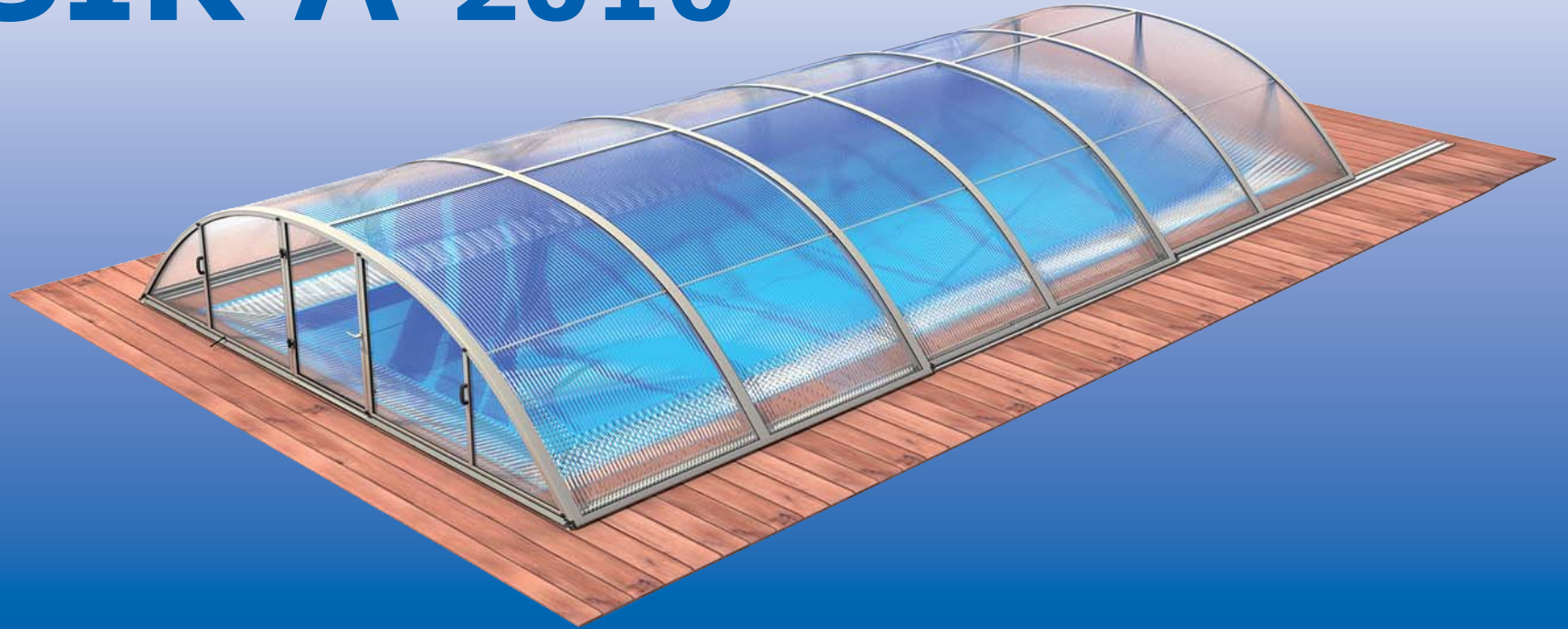

REVIZE: 30. 10. 2015

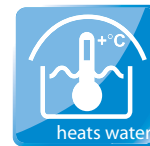

**BG**  
 Тръгването на Слънцето: нова конструкция  
 и съоръжение в АНЧОК. № П 90-300  
 За повече информация относно нашите услуги посетете нашия уебсайт или се свържете с нашите експерти по телефона или лично на място.

**DE**  
 Schwimmplatzüberdachung: neue Konstruktion  
 und Vorrichtung in ANCHOK. № П 90-300  
 Die Schwimmplatzüberdachung ist eine innovative und sichere Lösung für Ihr Schwimmbecken. Sie ist leicht zu installieren und bietet Ihnen einen optimalen Schutz vor Sonne und Regen.

**ES**  
 Cubierta de piscina: nueva forma  
 Construcción de ANCHOK. № П 90-300  
 Este tipo de cubierta es ideal para proteger su piscina de la luz solar y la lluvia, manteniendo el agua fresca y limpia.

**FR**  
 Abris de piscine: nouvelle forme  
 Construction de ANCHOK. № П 90-300  
 Cette nouvelle forme de couverture de piscine est idéale pour protéger votre piscine des rayons du soleil et de la pluie.

**HU**  
 Medencefedélzetek: új formák  
 ANCHOK. № П 90-300  
 A medencefedélzetek új formái ideálisak a napfénytől és az esztől való védelemre.

**CN**  
 游泳池 遮阳棚  
 新设计 ANCHOK. № П 90-300  
 这款新设计的游泳池遮阳棚可以有效阻挡阳光和雨水，保持水质清新。

**LT**  
 Šilumos vieta šiluminė apsauga  
 Nauja ANCHOK. № П 90-300  
 Naujas šilumos apsaugos būdas, kuris padeda išlaikyti vandenį šilumą ir apsaugo jį nuo lietaus.

**PL**  
 Zadas basenów: nowa konstrukcja  
 Zbudowana w ANCHOK. № П 90-300  
 Nowa konstrukcja dachu basenów, która zapewnia doskonałą ochronę przed słońcem i deszczem.

**RU**  
 Тёплое место: новая конструкция  
 Задумана в АНЧОК. № П 90-300  
 Новая конструкция теплого места, которая помогает сохранить воду теплой и защищает её от дождя.

**SL**  
 Toplotno mesto: nova konstrukcija  
 V ANCHOK. № П 90-300  
 Nova konstrukcija toplega mesta, ki vam pomaga ohraniti vodo toploto in zaščiti pred dežjem.

**CZ**  
 Bazénová zastřešení: nová konstrukce  
 Vytvářeno v ANCHOK. № П 90-300  
 Nová konstrukce bazénové zastřešení, která vám pomůže udržet vodu čistou a chránit ji před deštěm.

**DK**  
 Basenoverdækning: ny konstruktion  
 Udviklet i ANCHOK. № П 90-300  
 Ny konstruktion af basenoverdækning, der hjælper dig med at holde vandet rent og beskytte det mod regn.

**EE**  
 Basenikatteded: uus konstruktsioon  
 Arendatud ANCHOK. № П 90-300  
 Uus konstruktsioon basenikatteded, mis aitab hoida vett puhtana ja kaitseb seda vihma eest.

**GB**  
 The swimming pool enclosure: new design  
 Constructed in ANCHOK. № П 90-300  
 The new design of the swimming pool enclosure helps to keep the water clean and protected from rain.

**HR**  
 Naštopne bazen: nova konstrukcija  
 Dizajnirano u ANCHOK. № П 90-300  
 Nova konstrukcija naštopne bazena, koja vam pomaže održavati vodu čistom i zaštićenoj od kiše.

**IT**  
 Copertura per piscine: nuova forma  
 Sviluppata in ANCHOK. № П 90-300  
 Nuova forma di copertura per piscine, che aiuta a mantenere l'acqua pulita e protetta dalla pioggia.

**LV**  
 Bāzēnu jumts: jauna konstrukcija  
 Attīstīta ANCHOK. № П 90-300  
 Jauna konstrukcija bāzēnu jumtiem, kas palīdz uzturēt ūdeni tīru un aizsargāt to no lietus.

**RO**  
 Acoperitură pentru piscină: nouă formă  
 Dezvoltată în ANCHOK. № П 90-300  
 Nouă formă de acoperitură pentru piscină, care ajută la menținerea apei curată și protejată de ploaie.

**SE**  
 Pooltak: ny konstruktion  
 Utvecklad i ANCHOK. № П 90-300  
 Ny konstruktion av pooltak, som hjälper dig att hålla vattnet rent och skyddat mot regn.

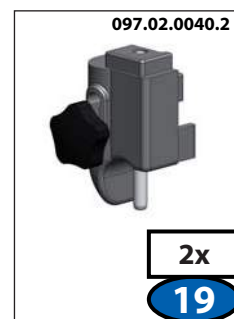
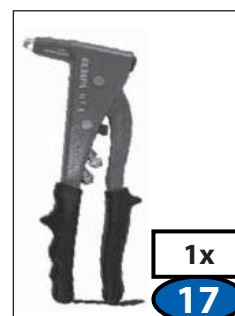
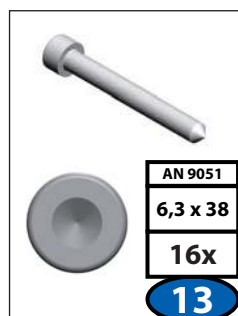
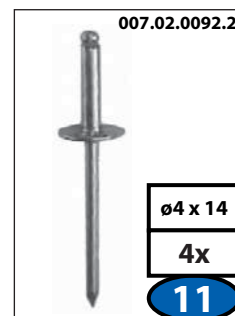
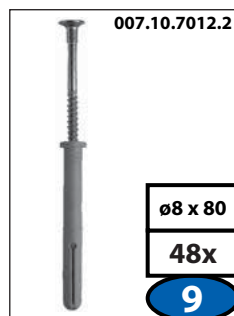
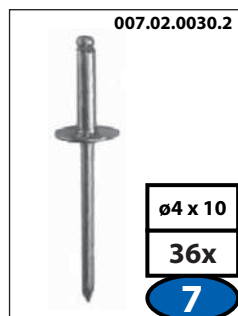
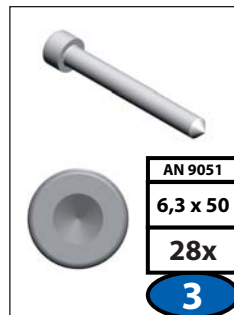
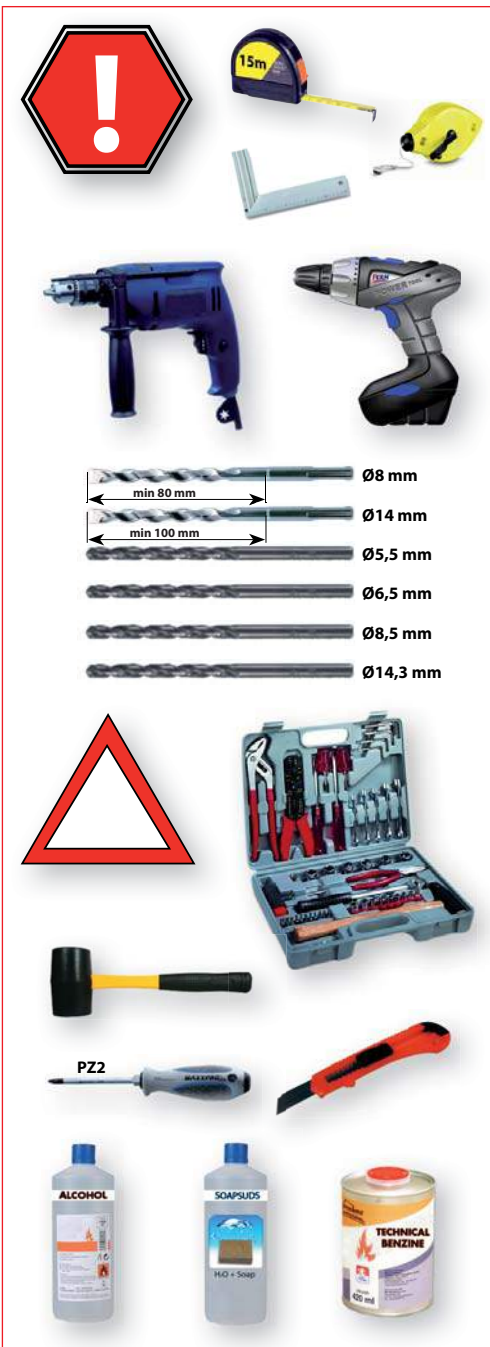

**SK**  
 Bazénová zastřešení: nová konstrukcia  
 Vytvárané v ANCHOK. № П 90-300  
 Nová konstrukcia bazénovej zastřešenia, ktorá vám pomôže udržať vodu čistú a chrániť ju pred dažďom.



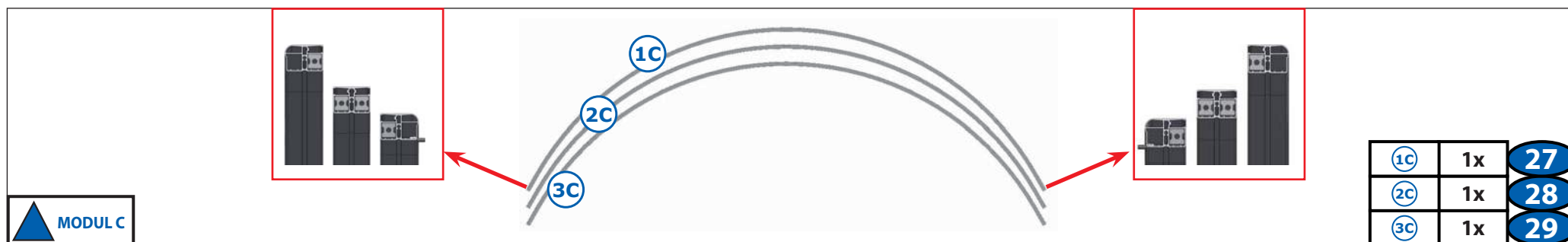
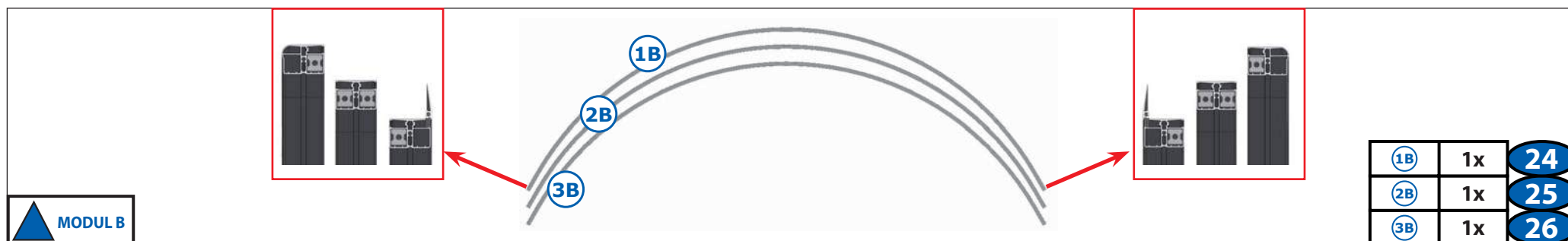
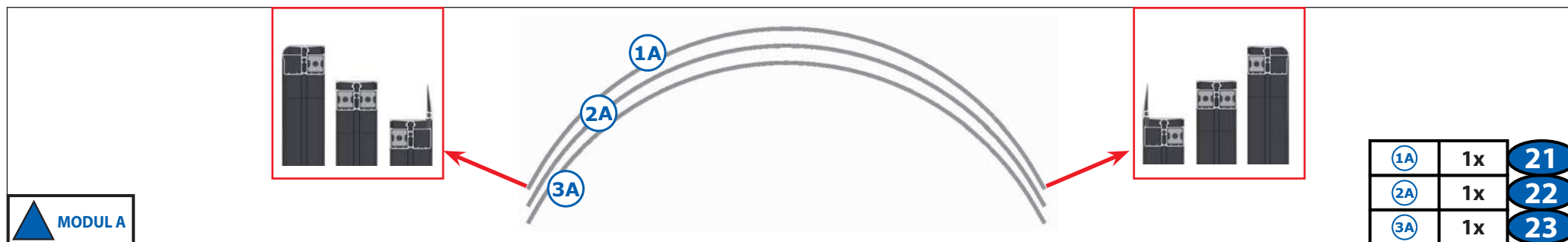
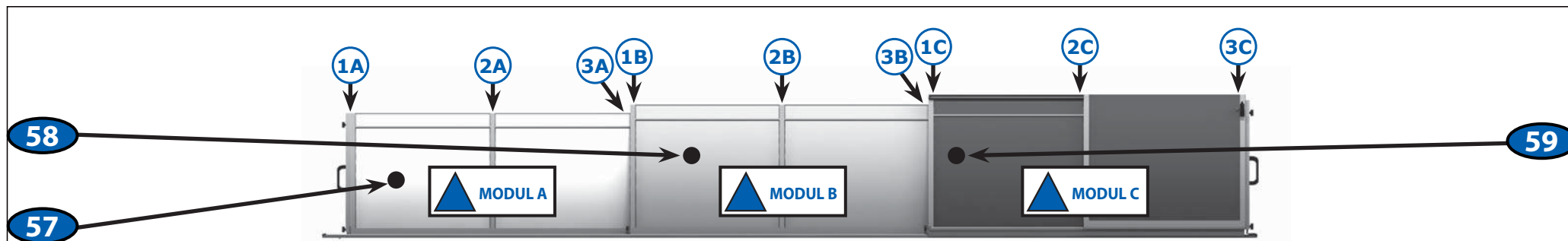

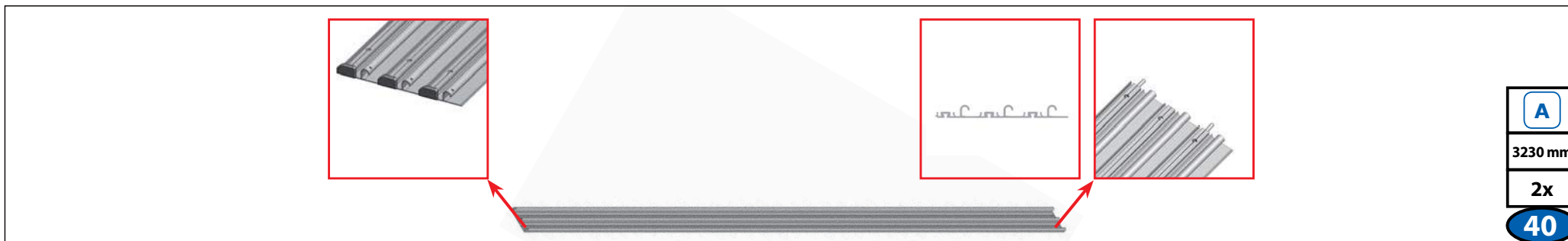
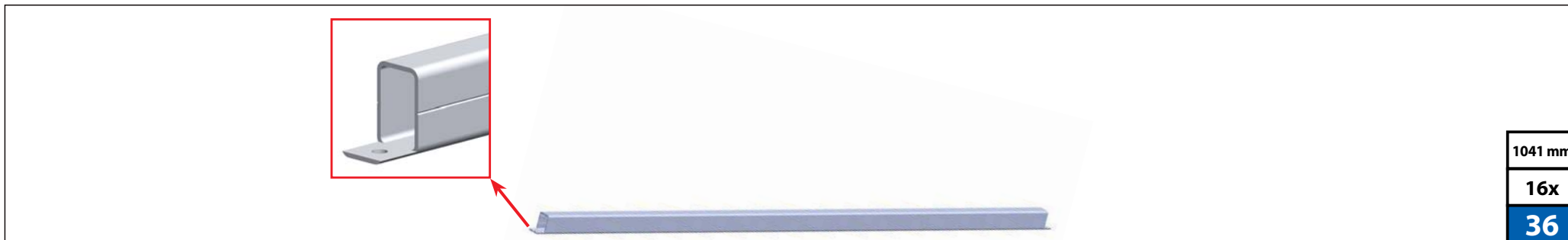

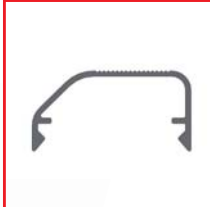



3230 mm
12x
<b>48</b>





**MODUL C**

1x
<b>50</b>



**MODUL C**

1x
<b>51</b>



**MODUL B**

1x
<b>52</b>



**MODUL B**

1x  
**53**

**MODUL A**

1x  
**54**

**MODUL A**

1x  
**55**



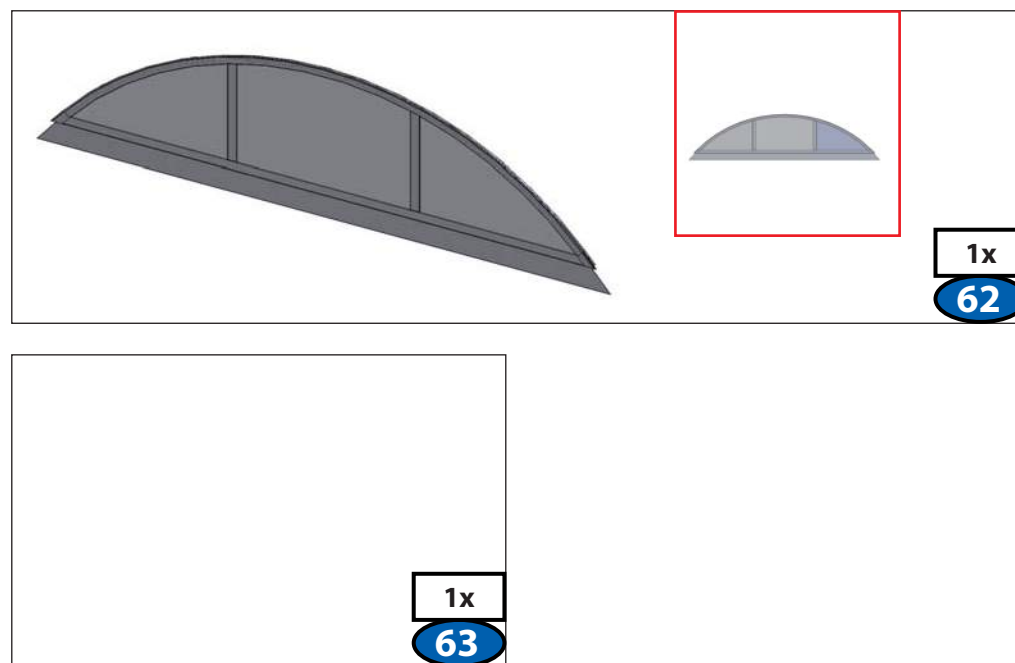
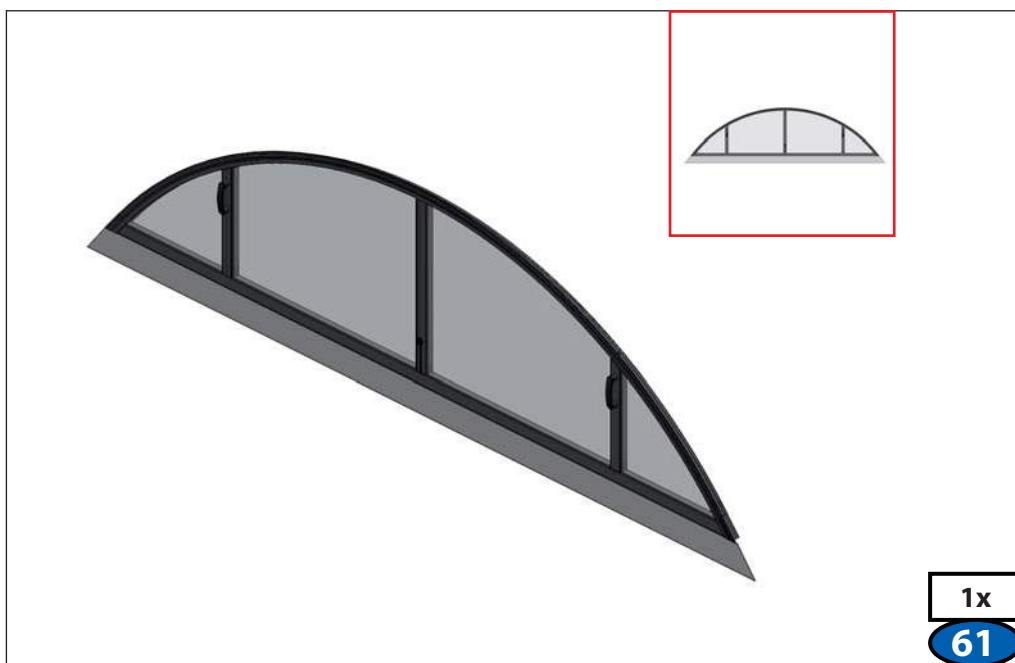
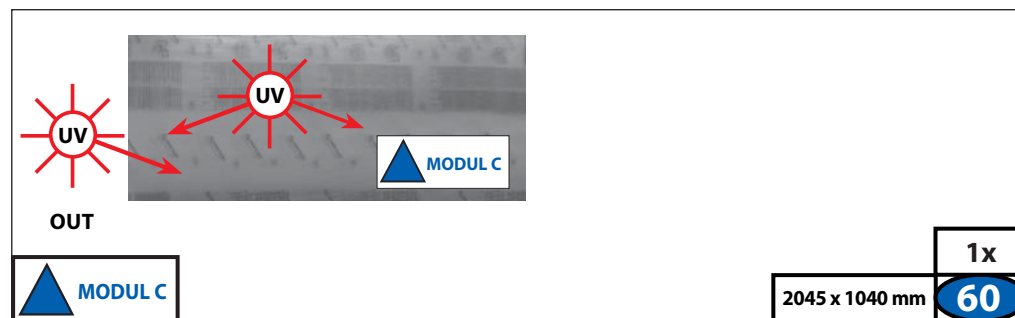
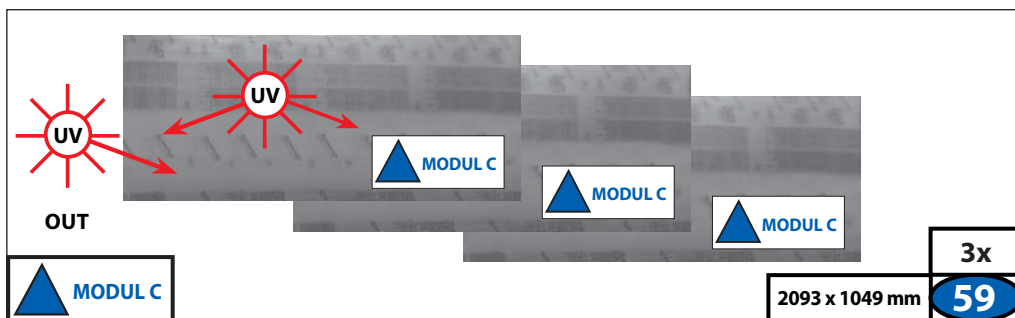
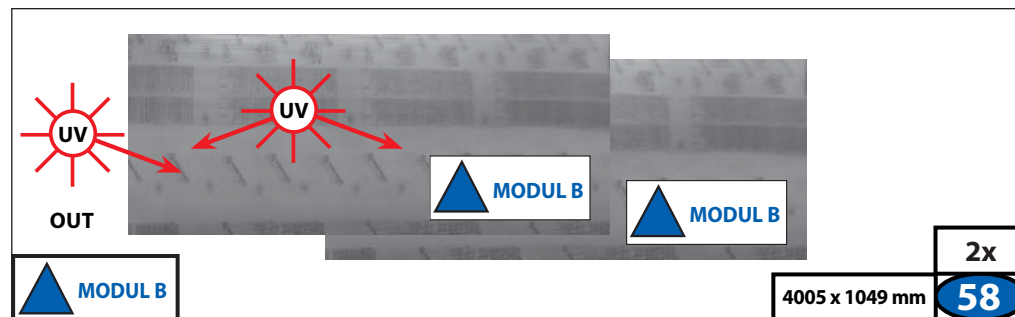
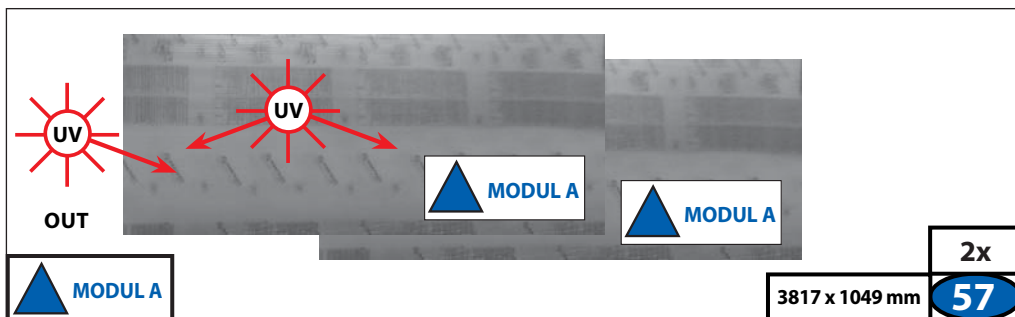

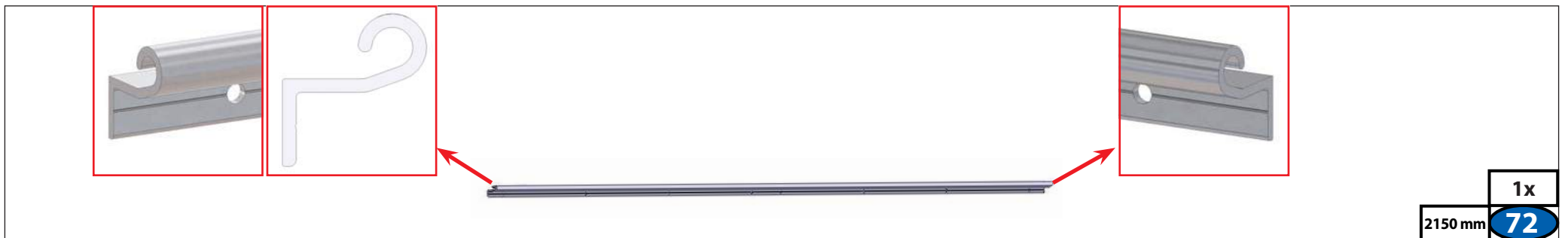
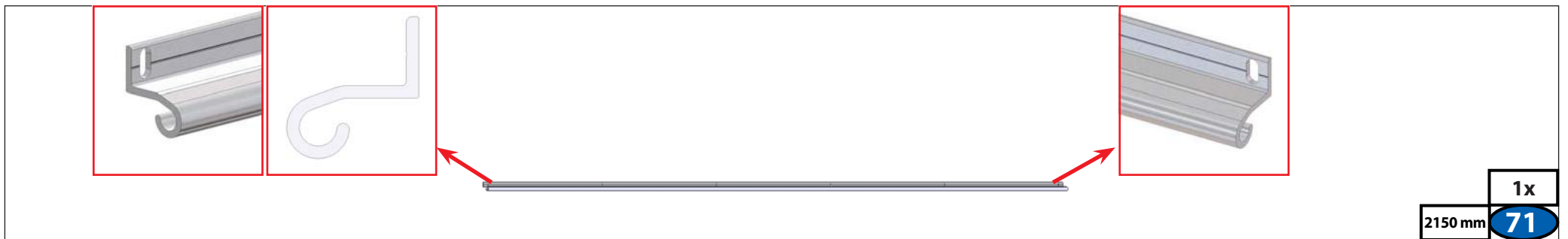
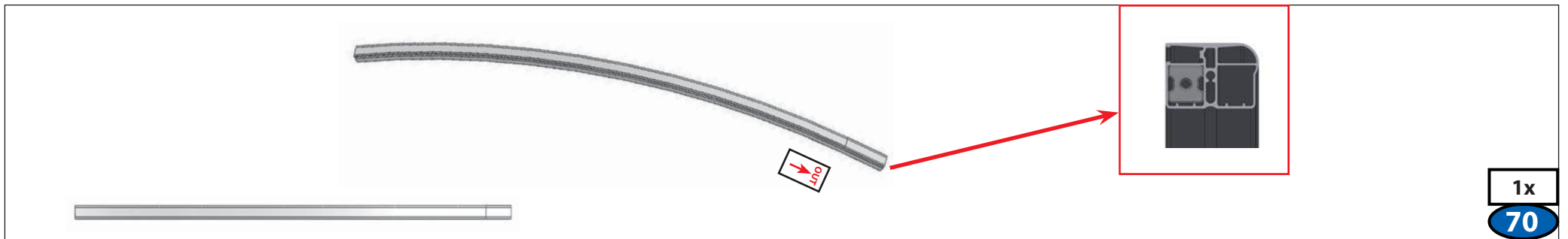
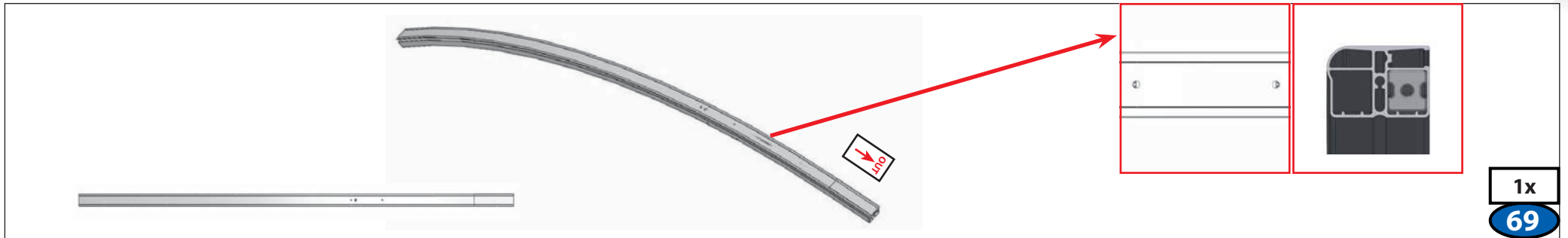



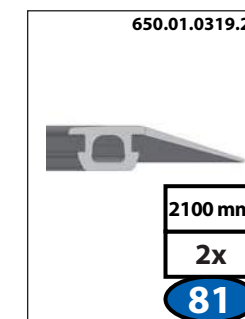
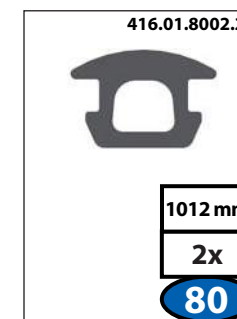
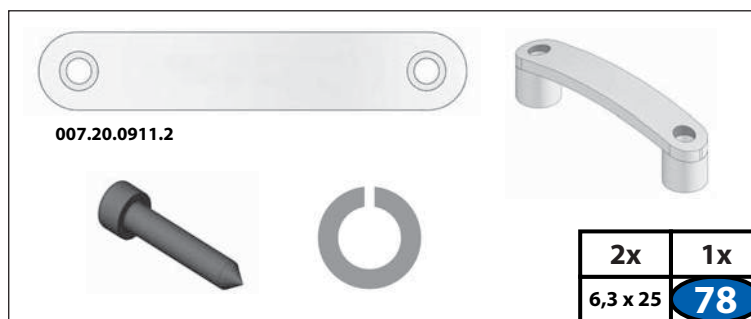
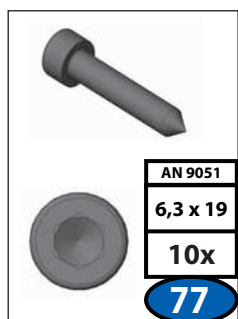
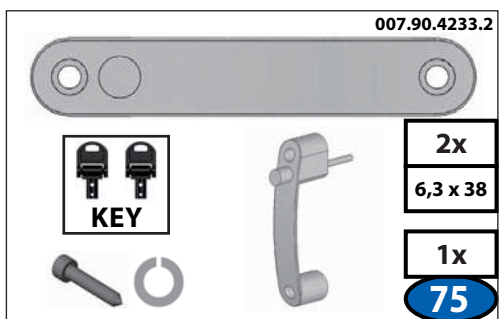
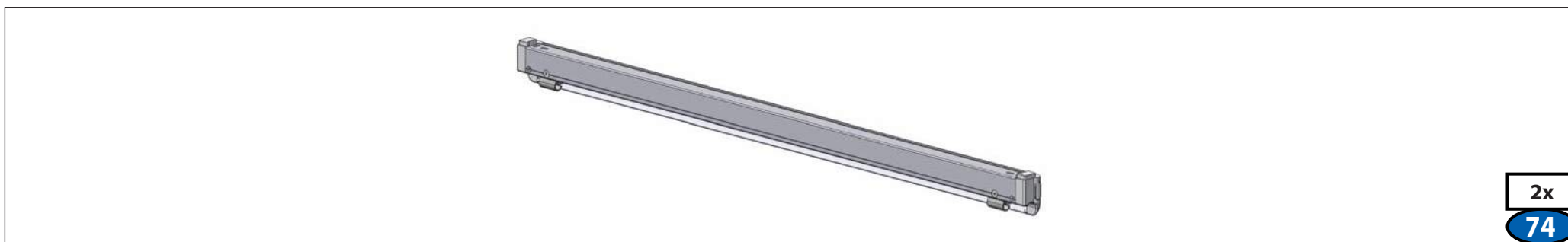
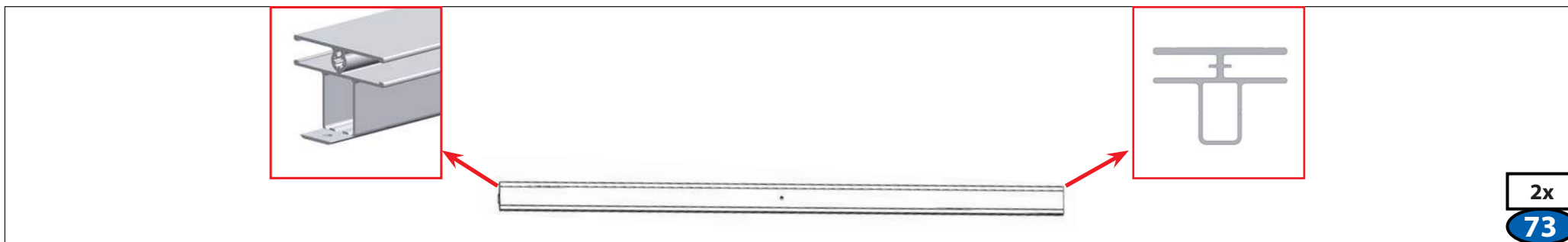

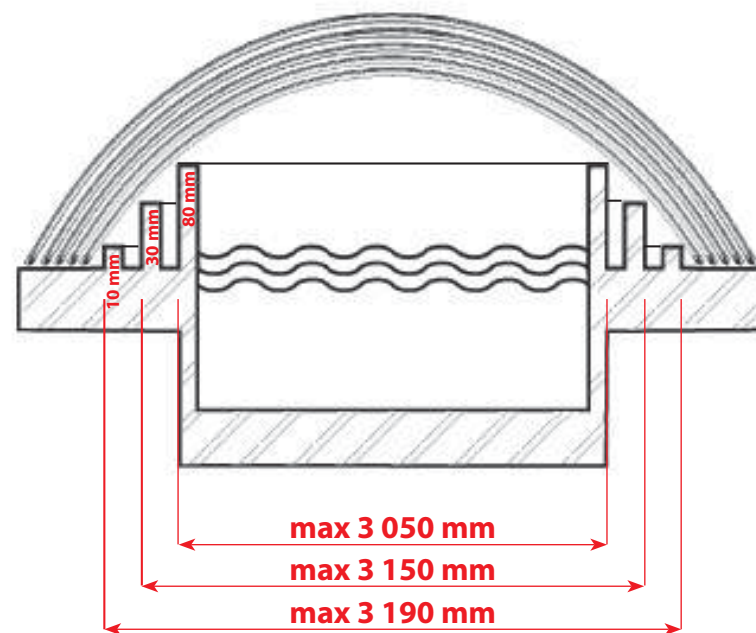
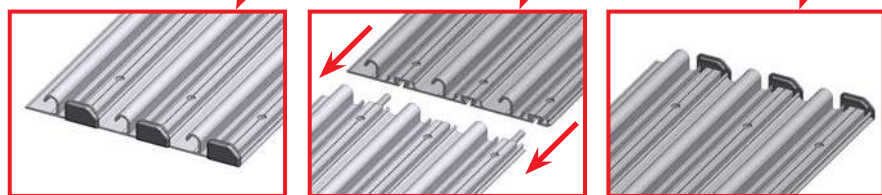
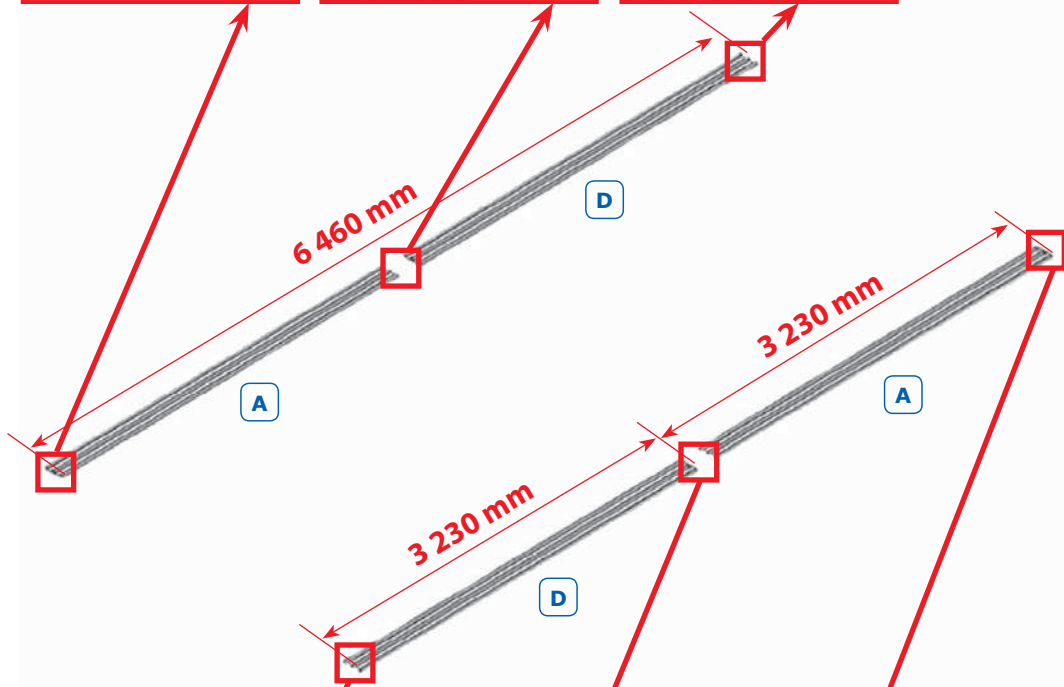
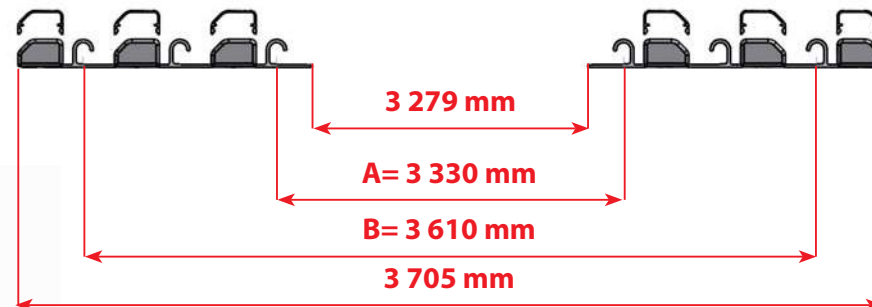
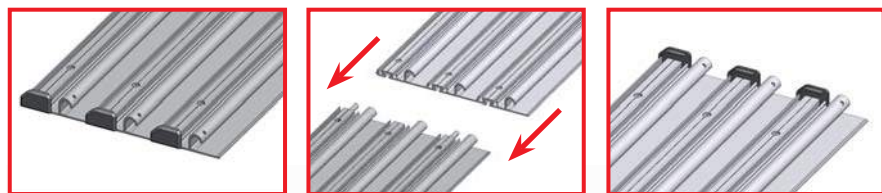

2x	41
2x	47



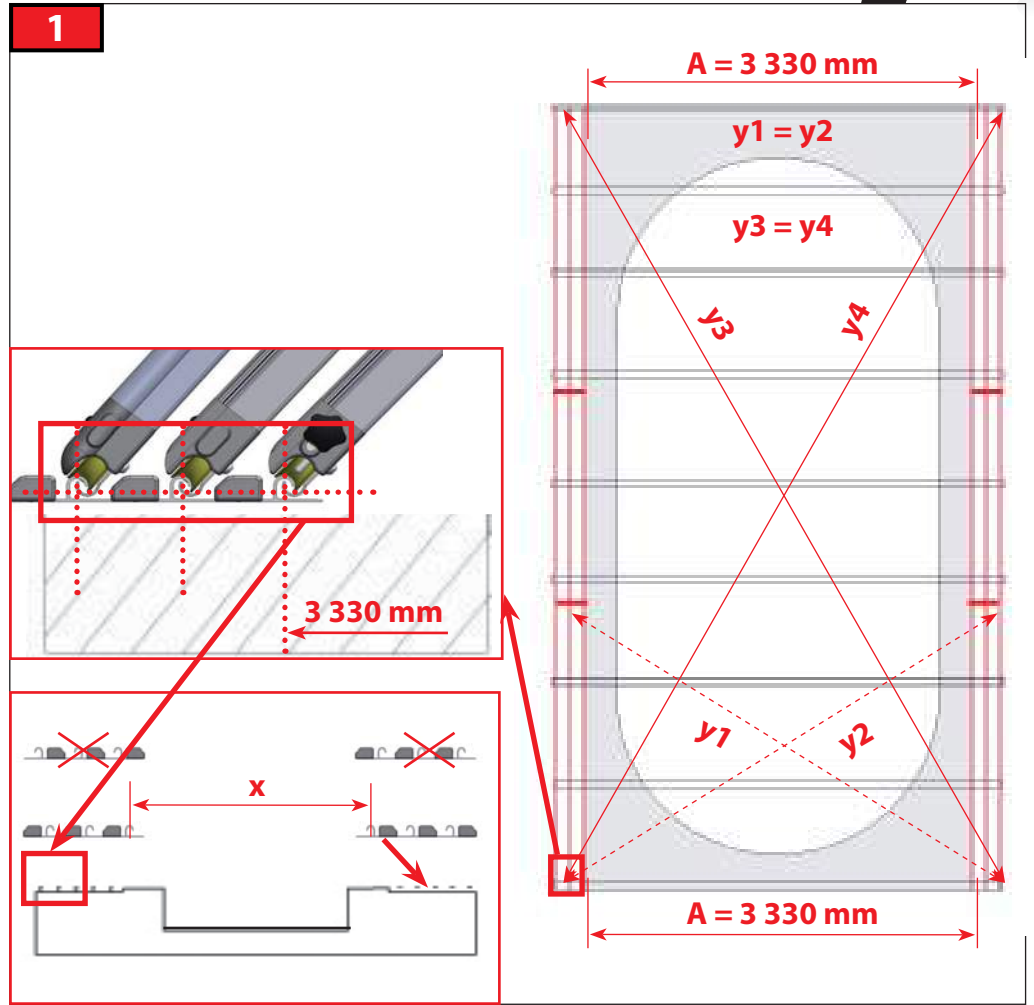
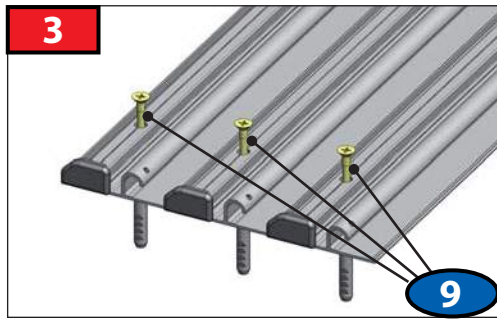
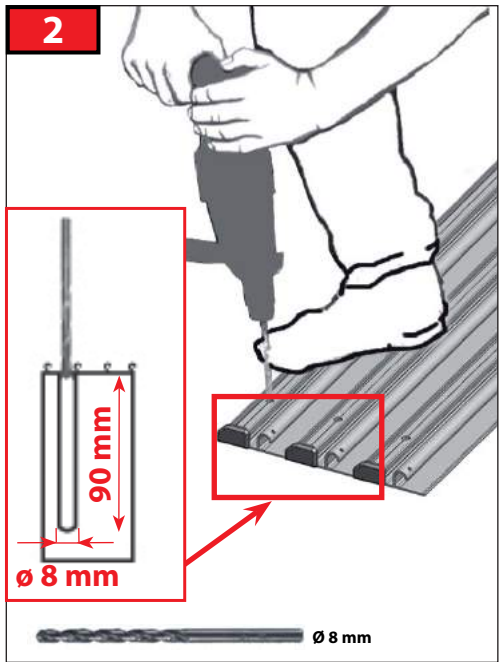
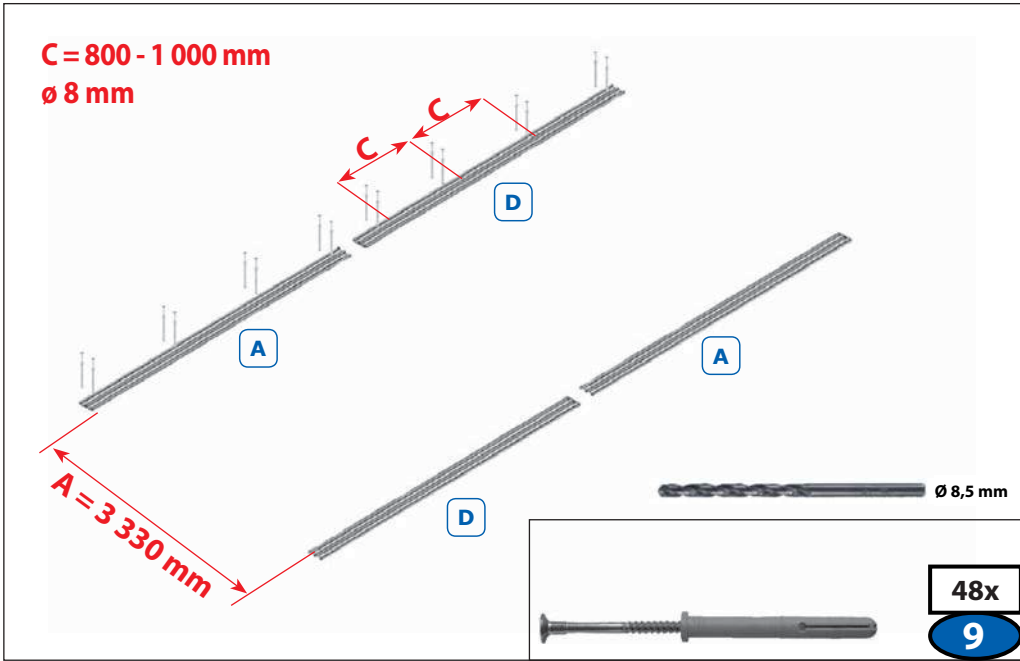

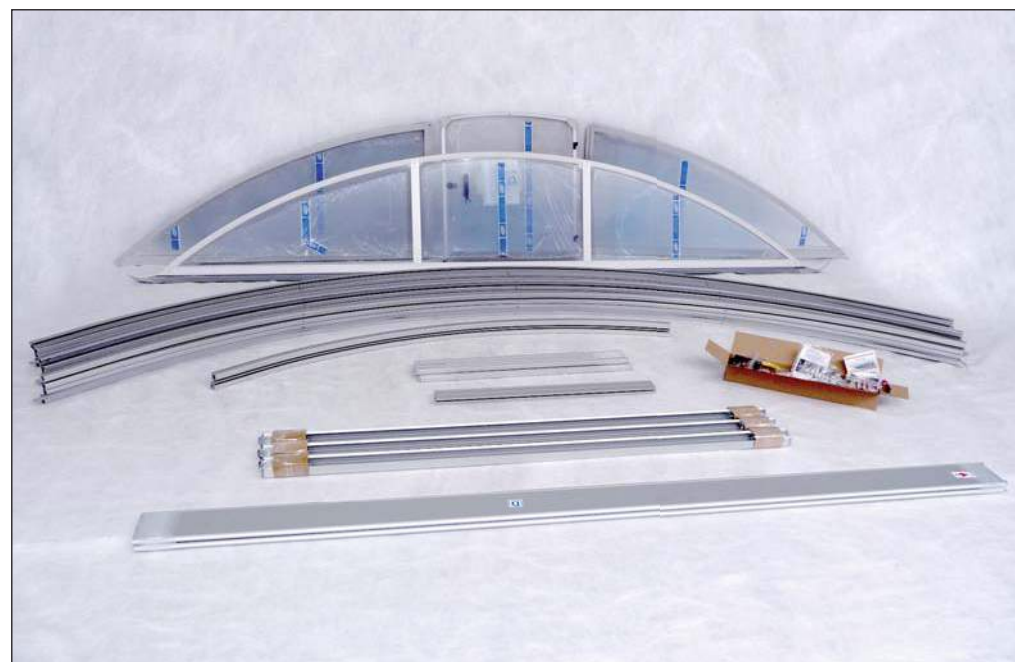



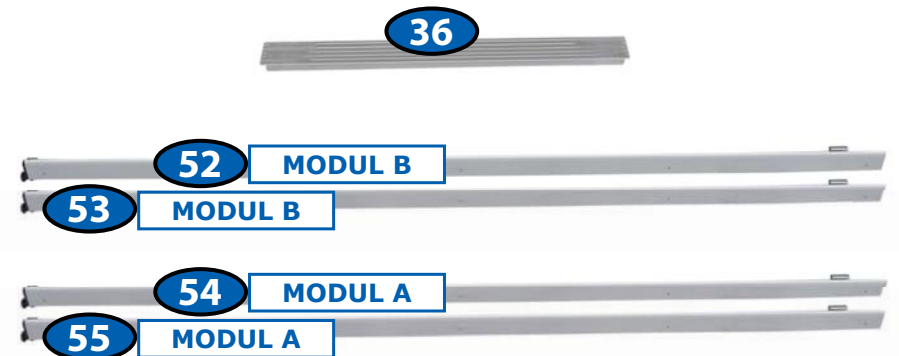
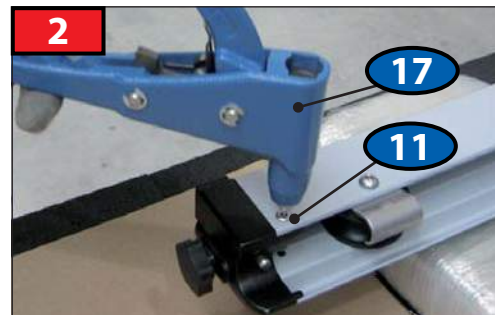
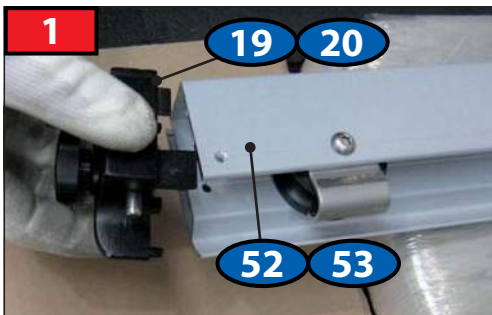
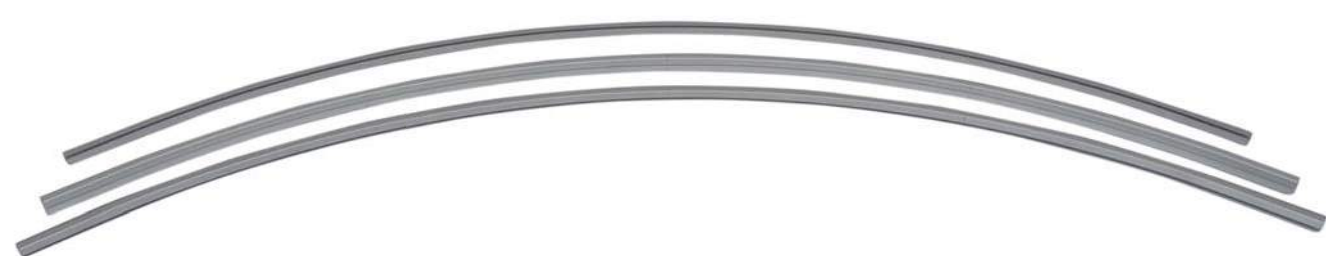
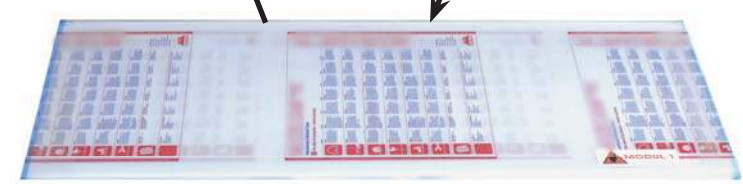
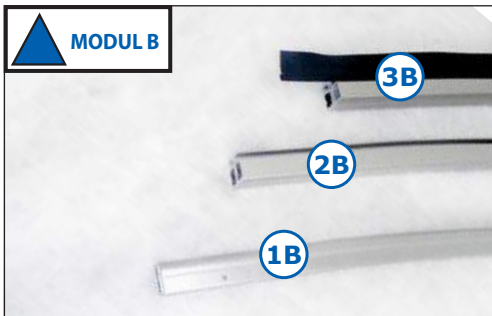
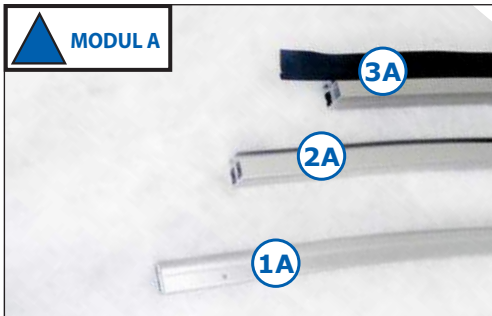
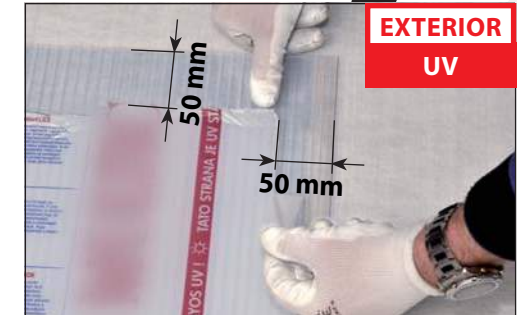

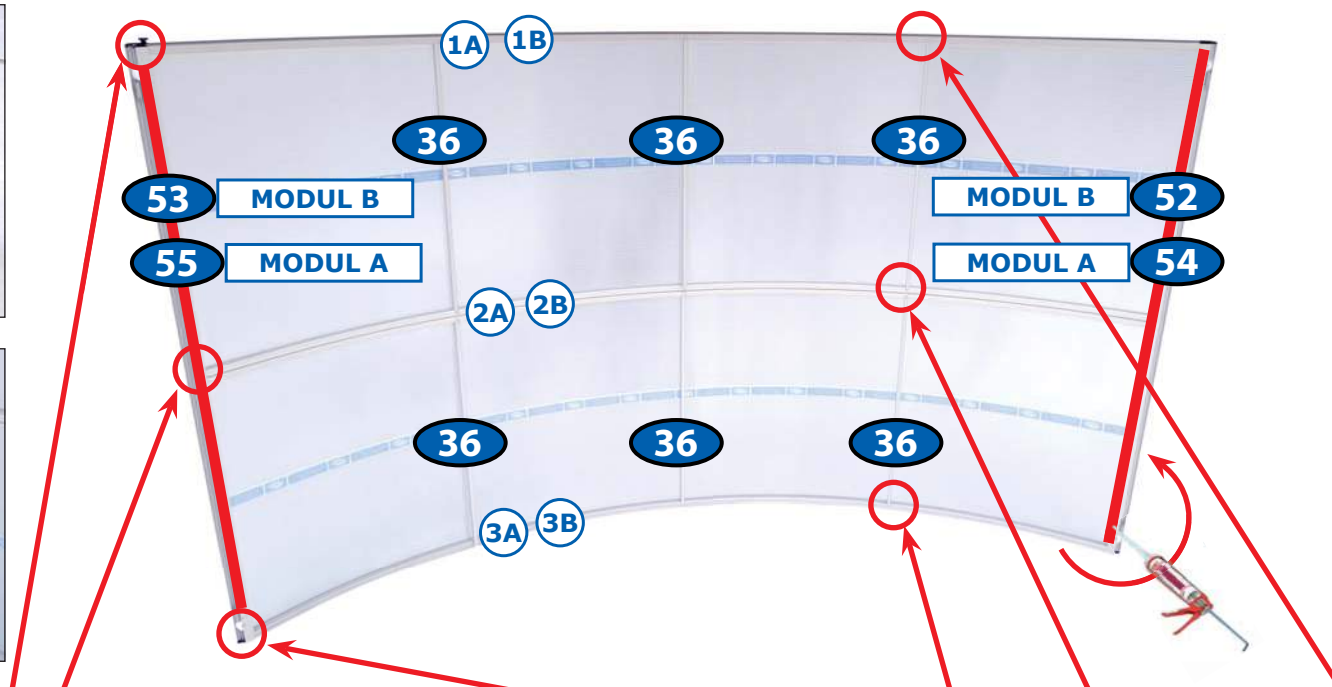
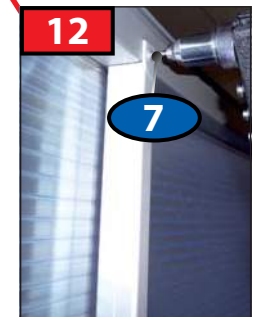
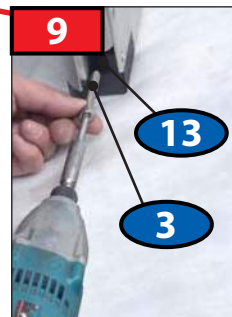
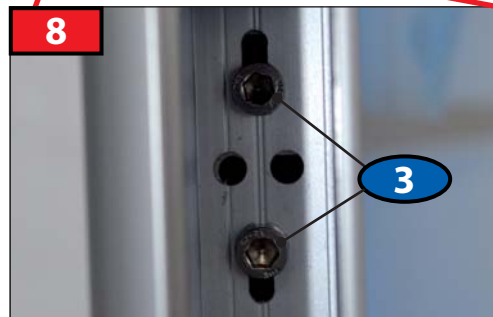
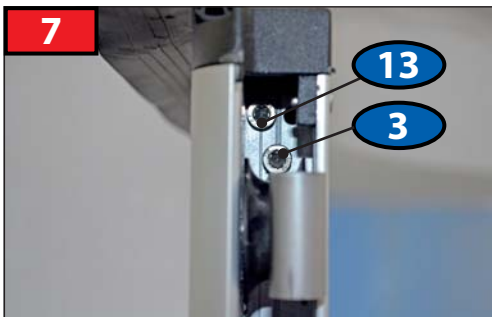
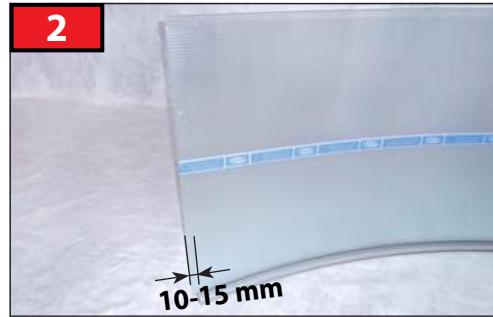



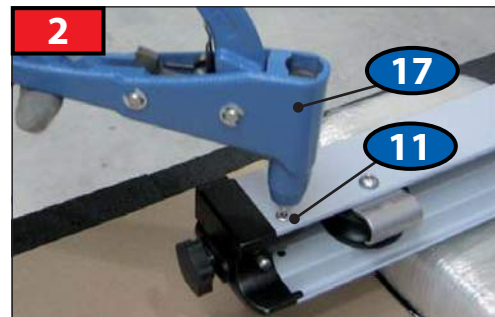
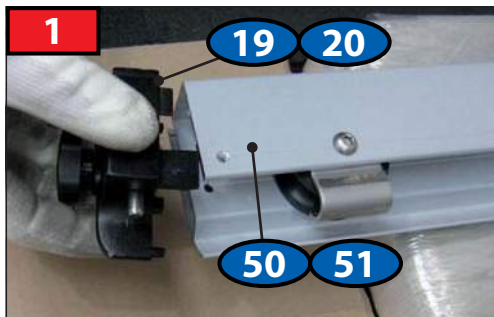
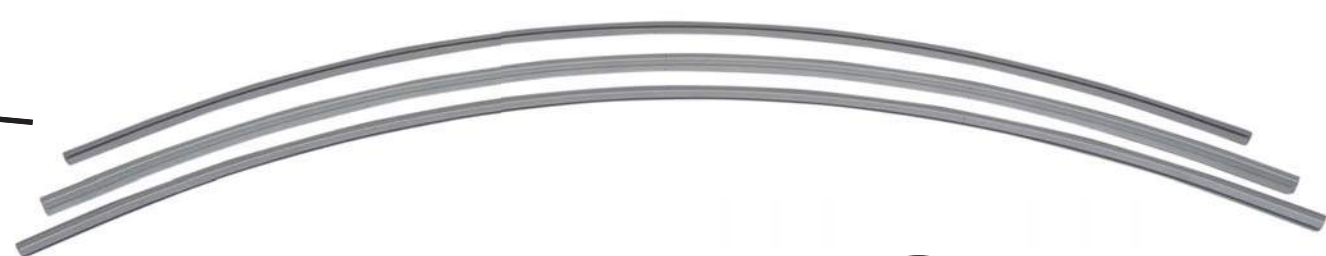
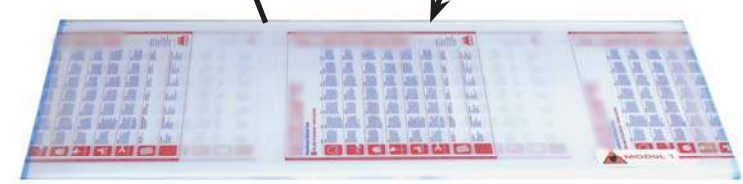
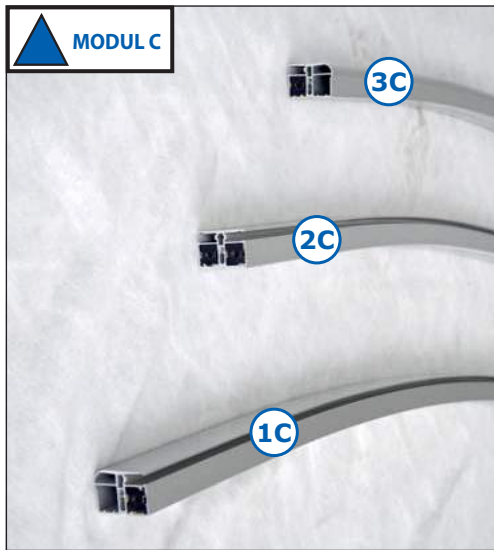
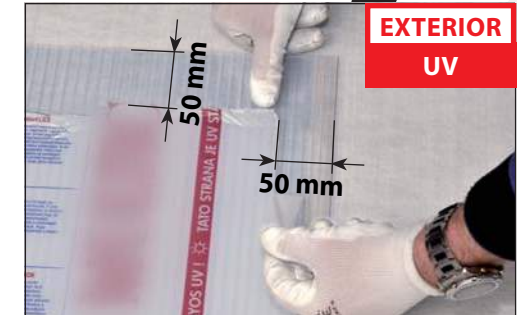



## DOOR LEFT

## DOOR RIGHT

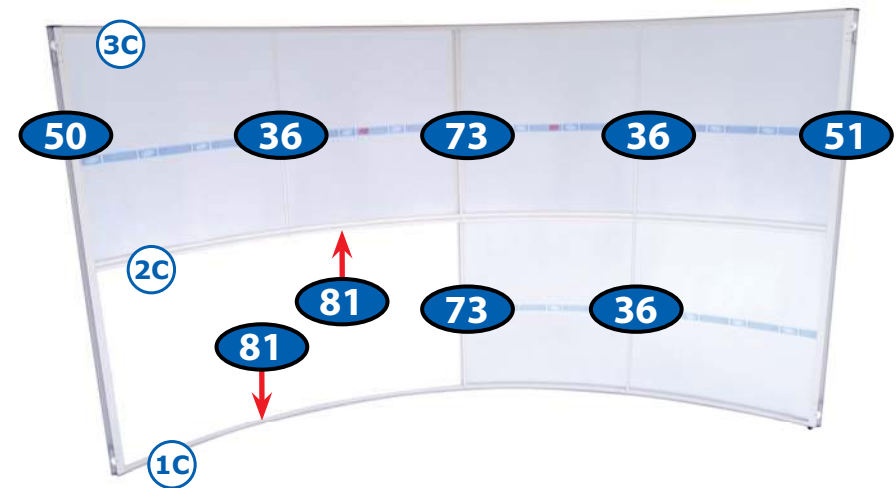
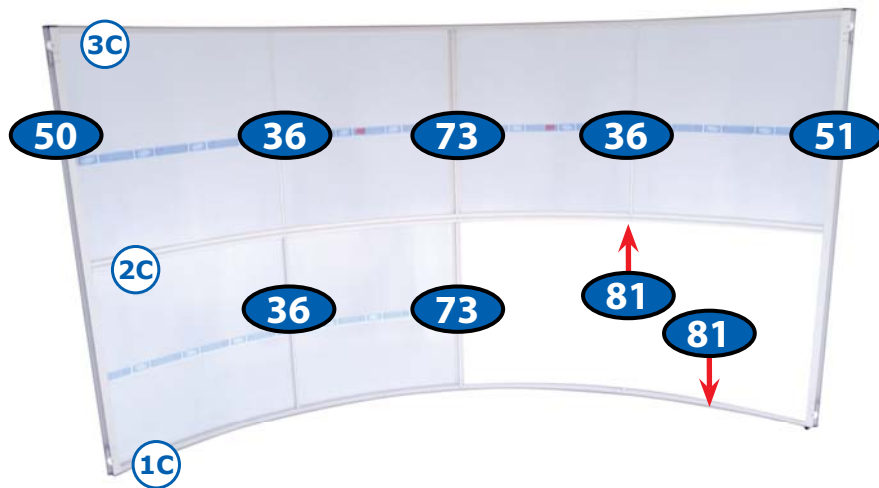
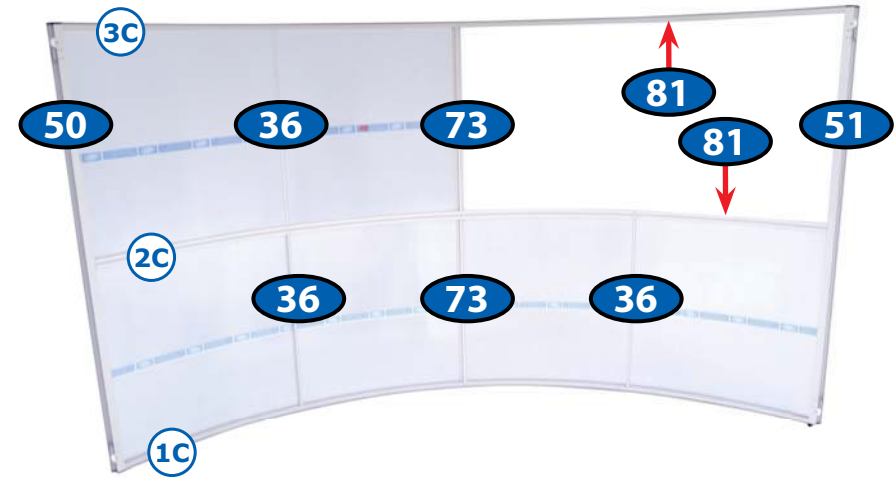
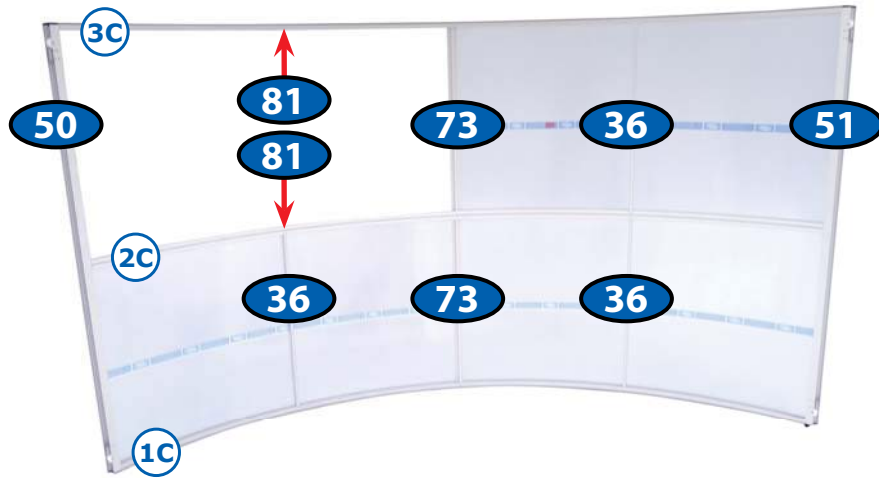



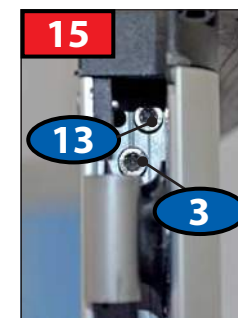
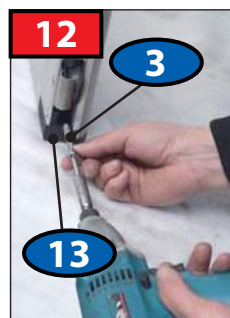
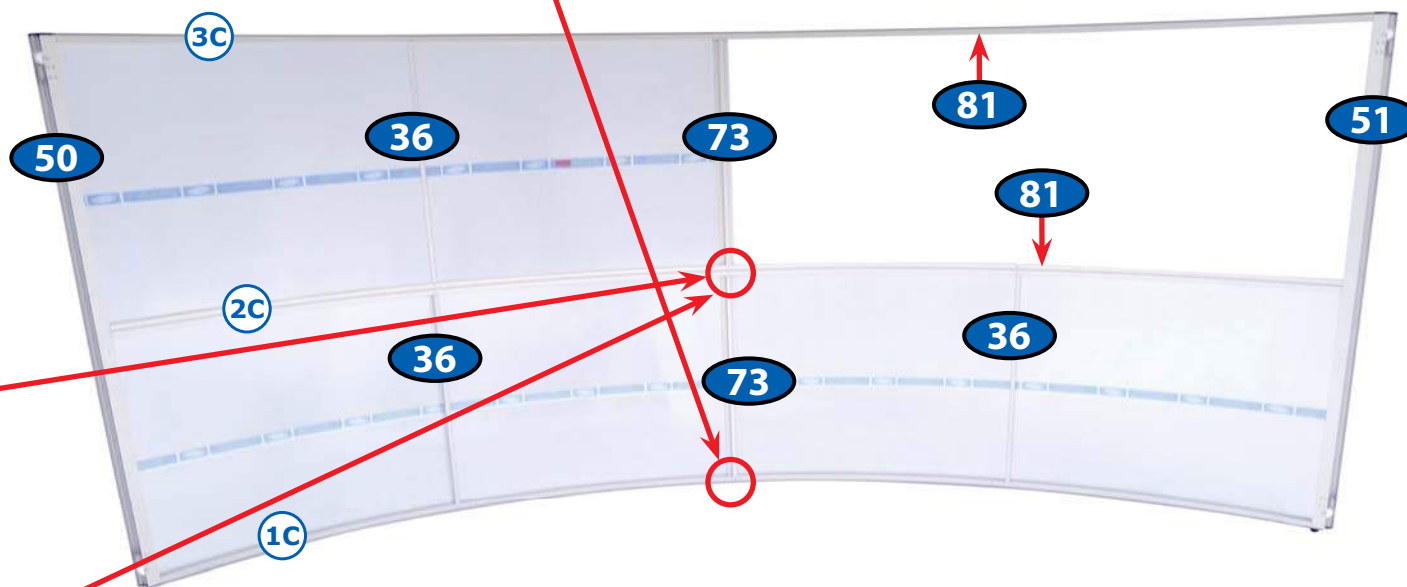

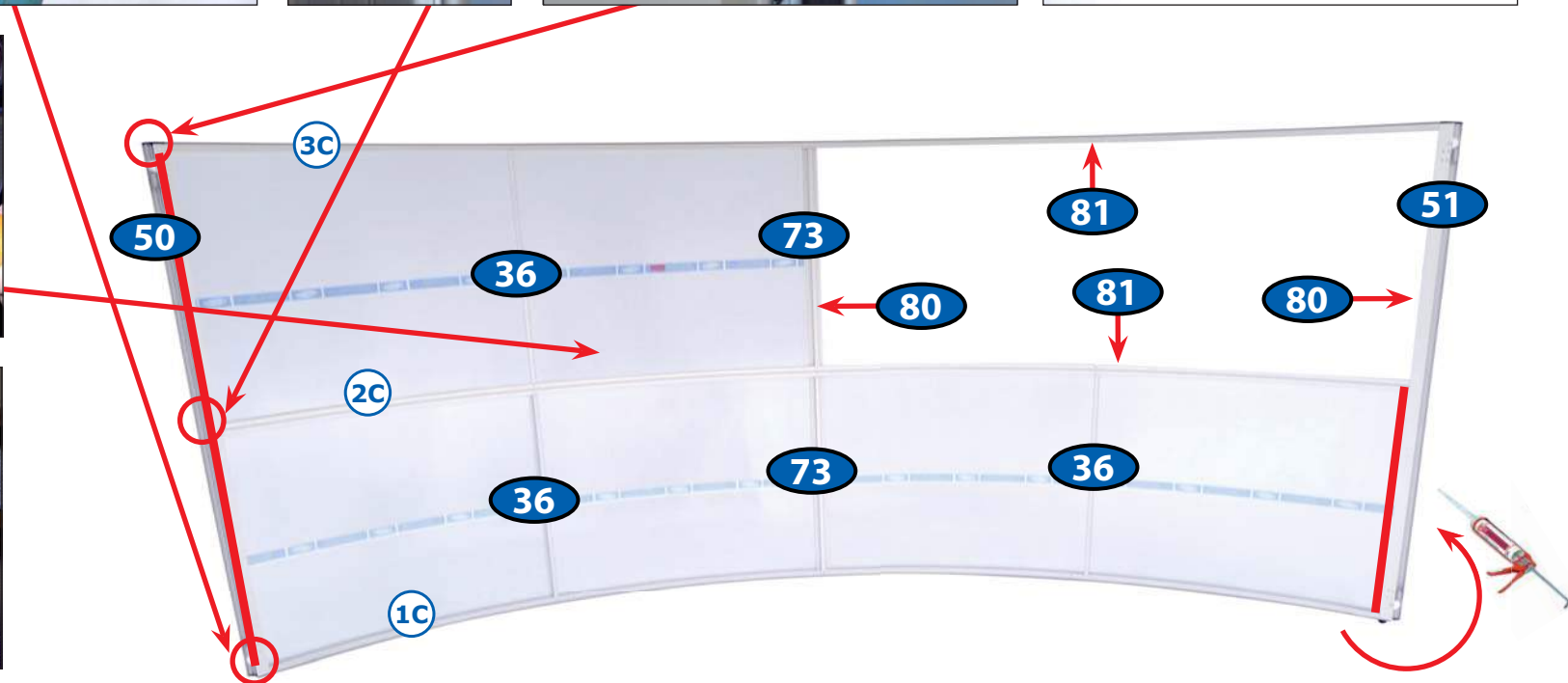
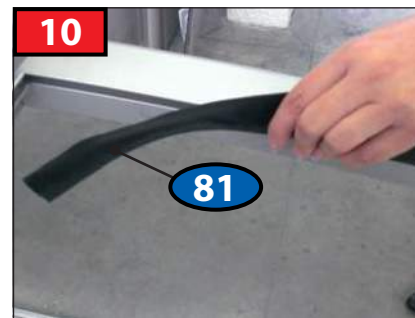
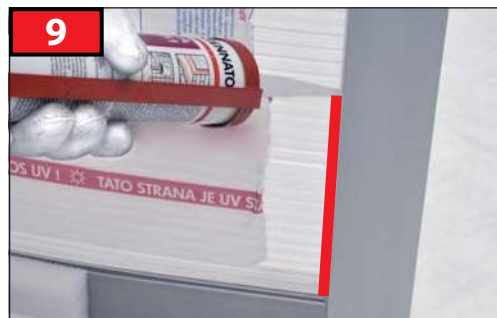
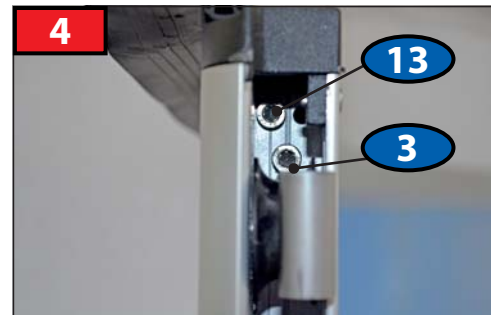



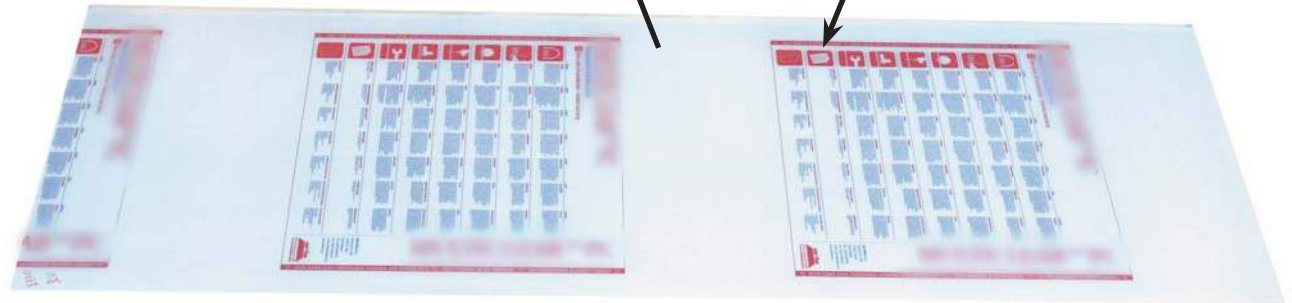
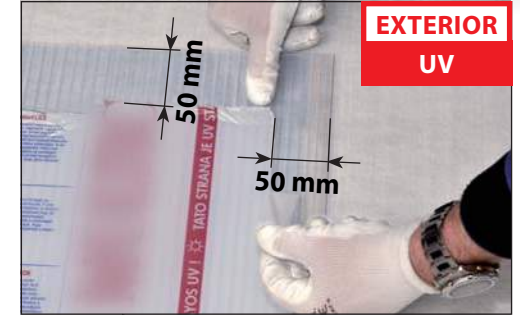
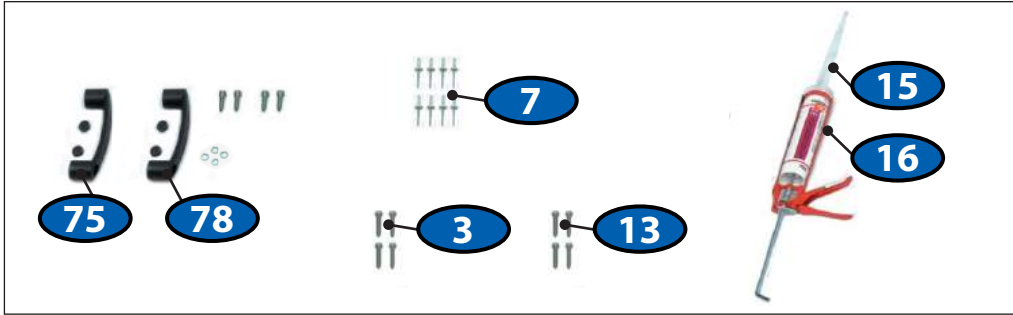

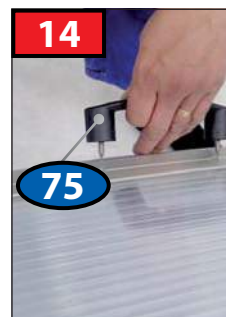
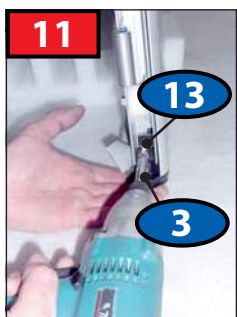
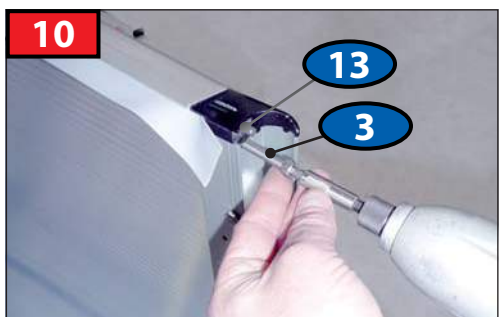
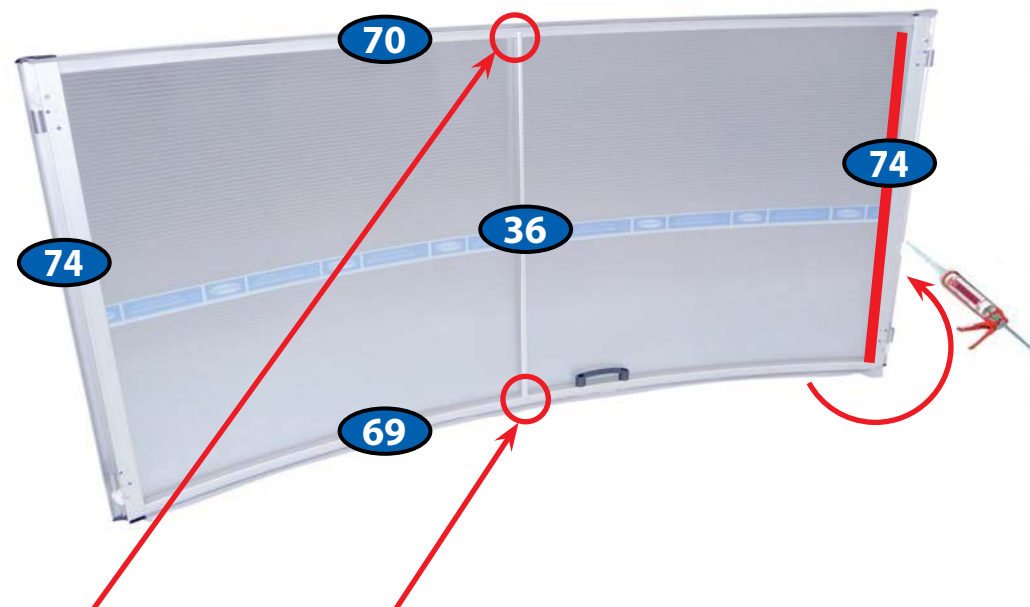



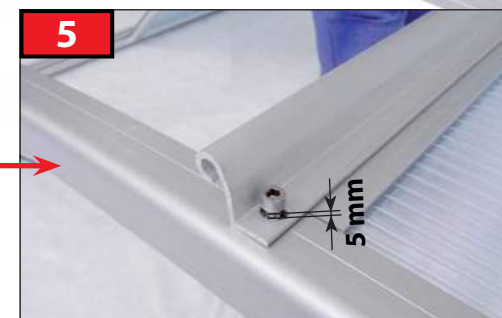
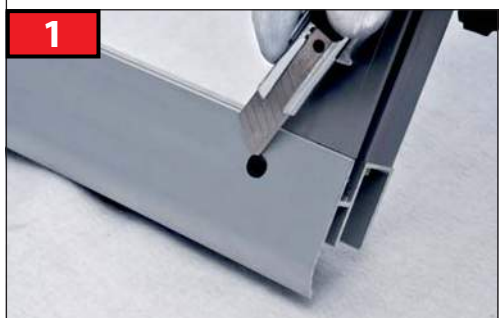
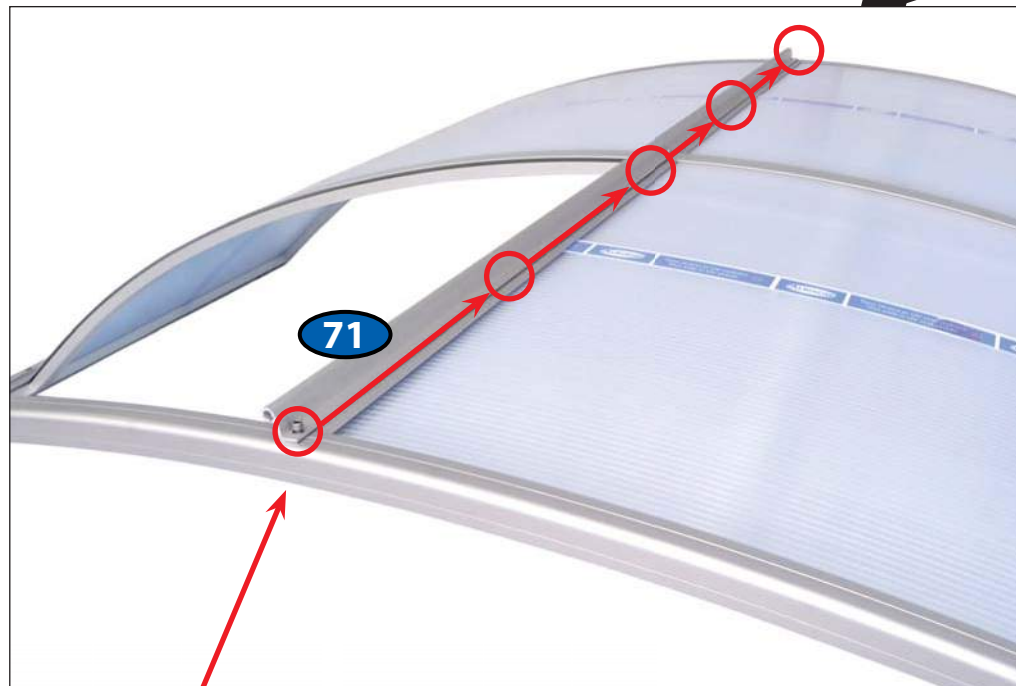

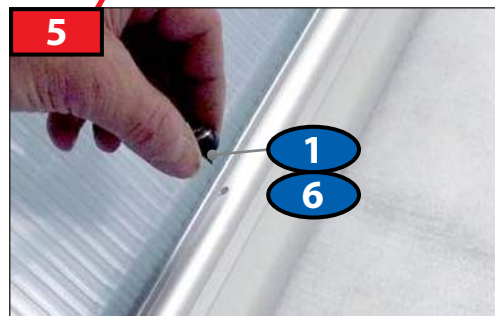
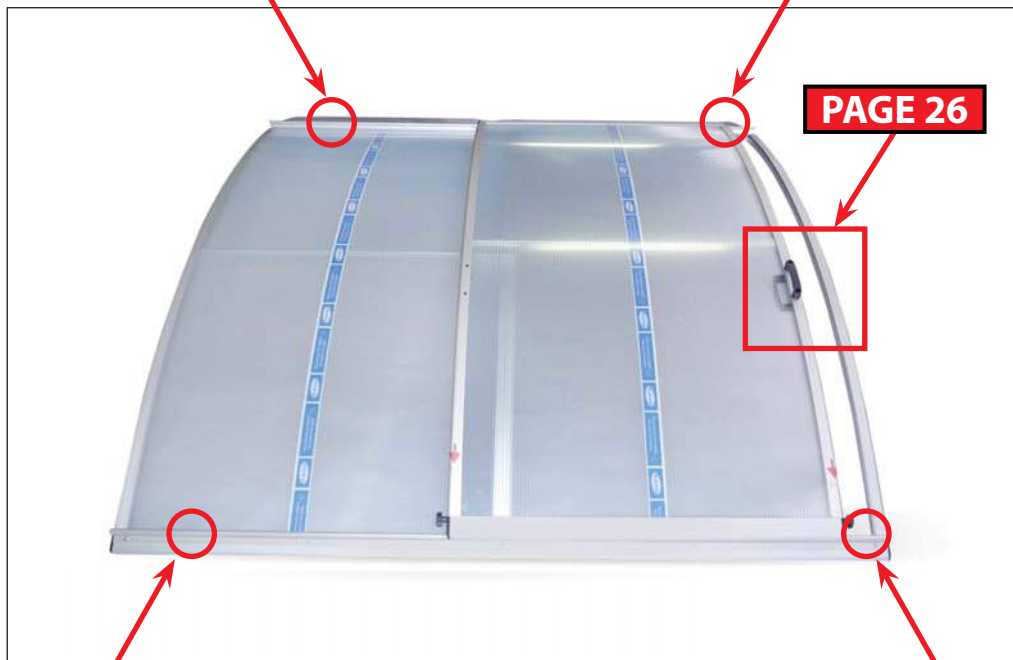
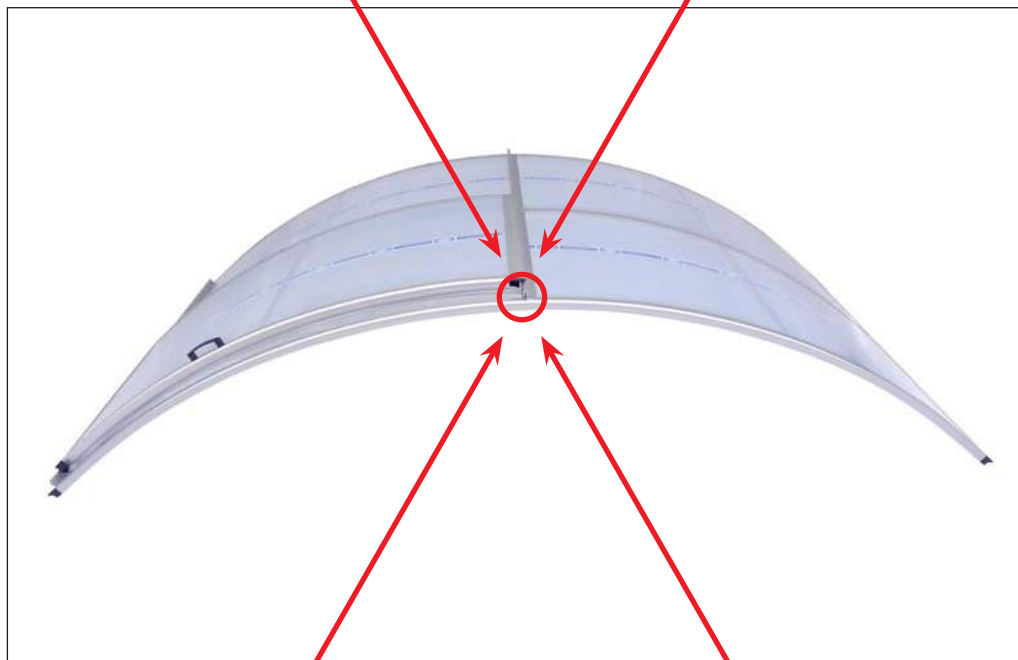

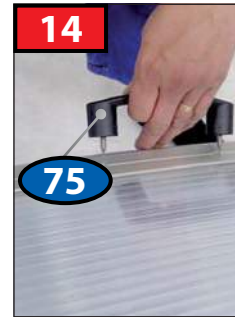
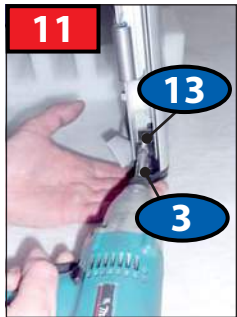
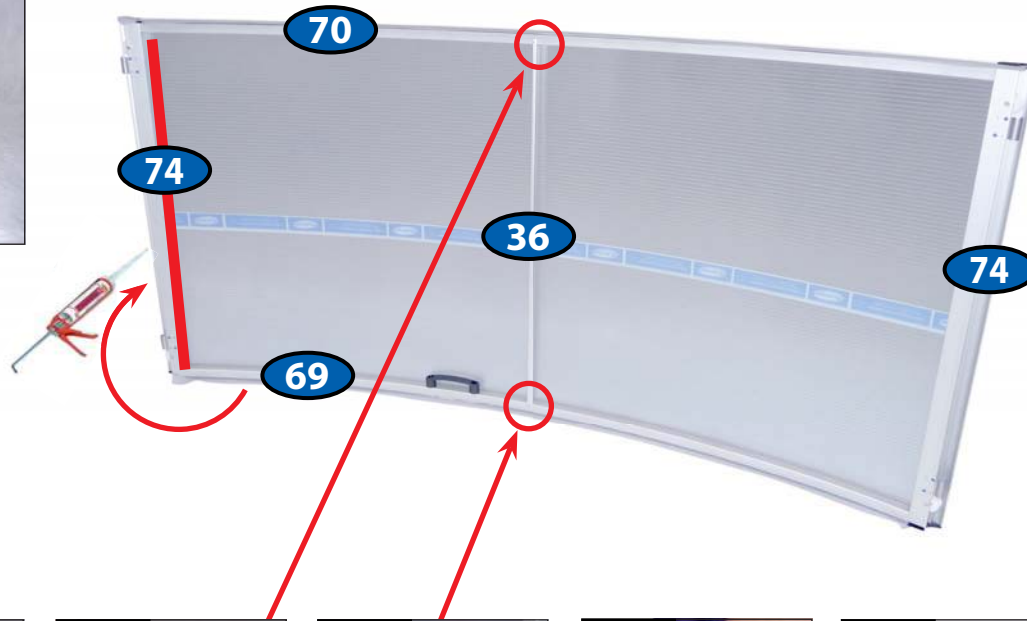



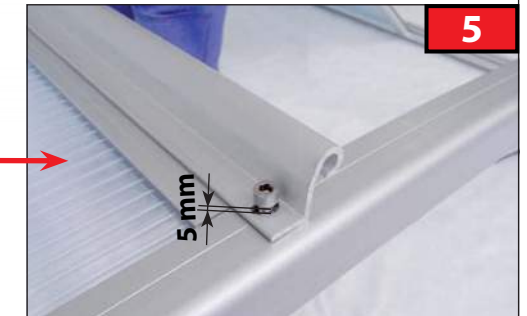
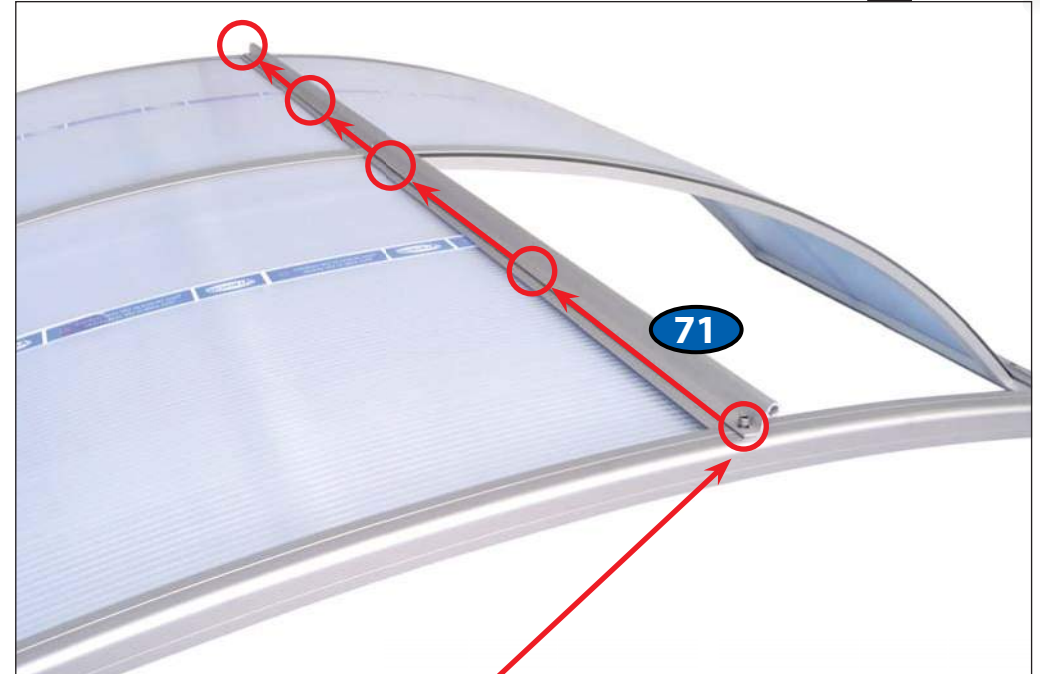

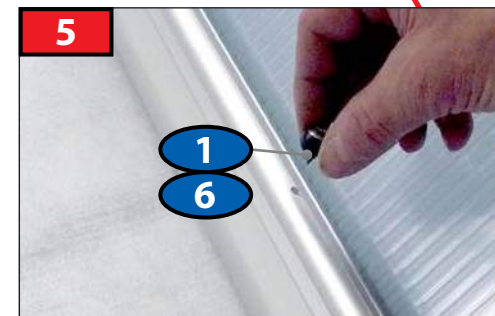
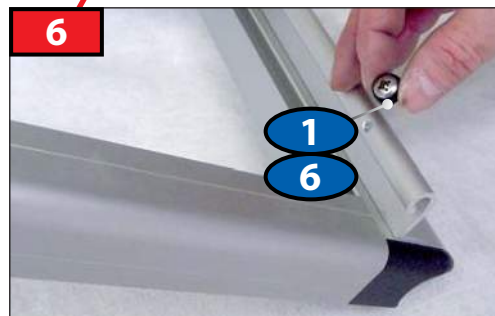
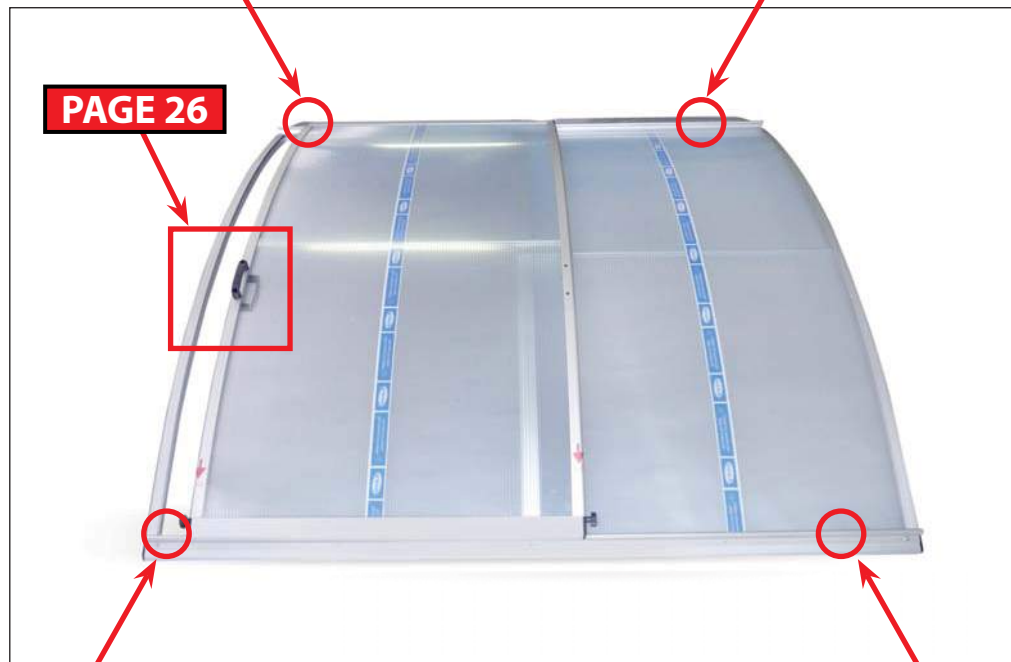
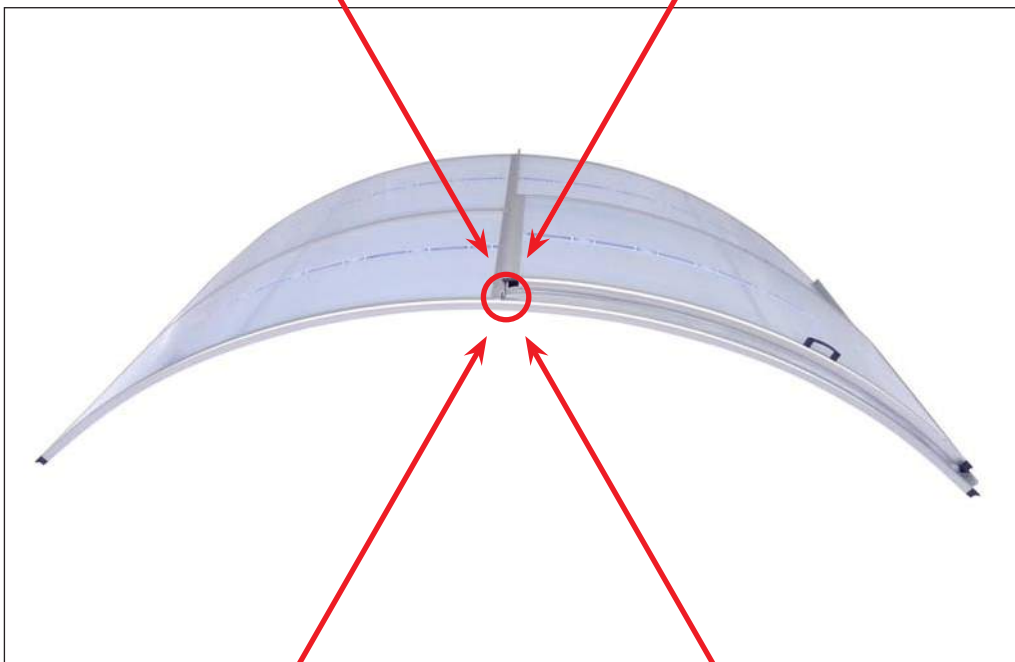



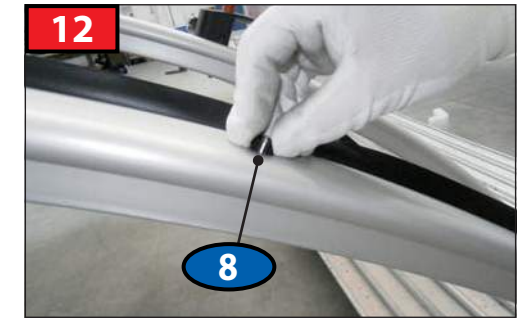
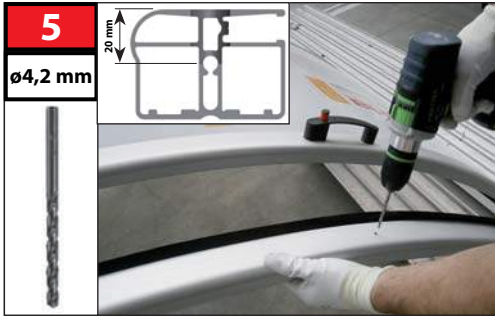



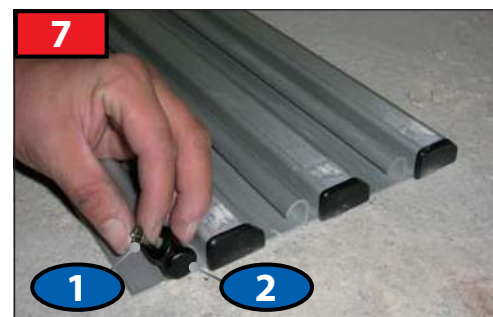
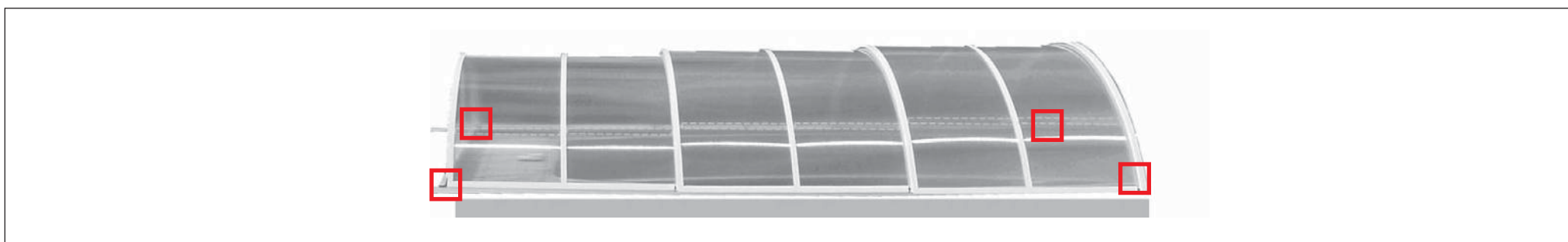
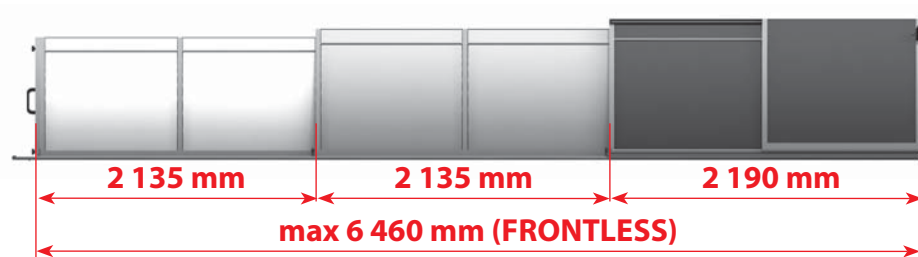

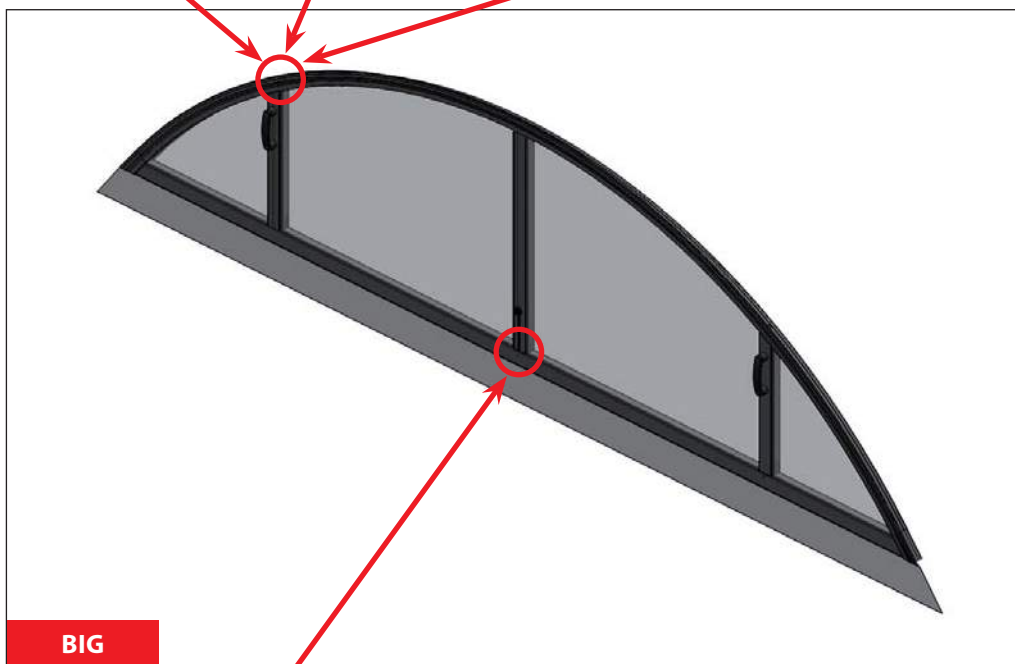

BIG

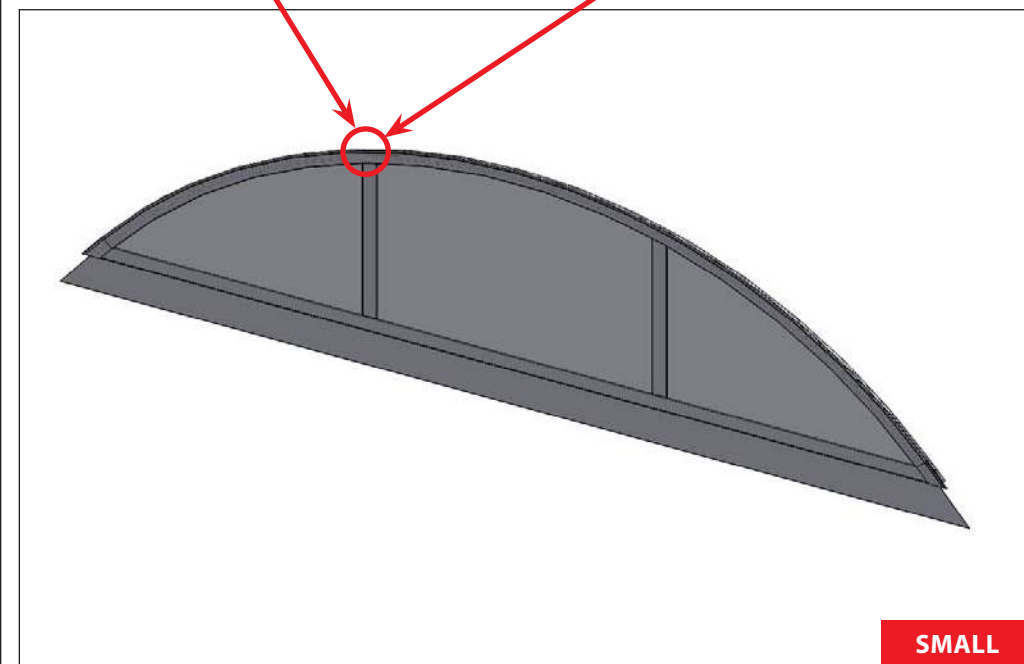
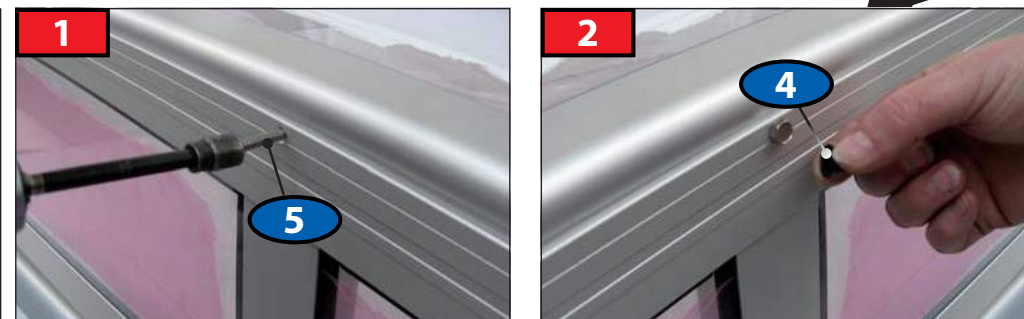

SMALL

